

9CAP / 9CAF / 9CHP / 9CHF

9 CHANNEL RADIO CONTROL SYSTEM

INSTRUCTION MANUAL



Technical updates and additional programming examples available at: <http://www.futaba-rc.com/faq/faq-9c.html>

TABLE OF CONTENTS

INTRODUCTION	3	Other Equipment	64
Additional Technical Help, Support and Service	3	GLIDER (GLID1FLP/2FLP) FUNCTIONS	65
Application, Export and Modification	4	Table of contents	65
Meaning of Special Markings	5	Getting Started with a Basic 4-CH Glider	66
Safety Precautions (do not operate without reading)	5	GLIDER-SPECIFIC BASIC MENU FUNCTIONS	68
Introduction to the 9C	7	Model type (PARAMETERS submenu)	68
Contents and Technical Specifications	9	GLIDER-SPECIFIC ADVANCE MENU FUNCTIONS	69
Accessories	10	BUTTERFLY	69
Transmitter Controls &		FLAP-AILE (GLID2FLP only)	70
Switch Identification/Assignments	11	AILE-FLAP (GLID2FLP only)	70
Charging the Ni-Cd Batteries	14	START OFS (Launch/Start Setup)	71
Stick Adjustments	15	SPEED OFS (Minimum Drag Setup)	71
Adjusting display contrast	15	HELICOPTER (SW...) FUNCTIONS	73
Changing mode	15	Table of contents and reference info for helicopters	73
Radio Installation & Range Checking	16	Getting Started with a Basic Helicopter	74
Aircraft Frequencies	17	HELI-SPECIFIC BASIC MENU FUNCTIONS	77
Transmitter Displays and Buttons	18	MODEL TYPE (PARAMETERS submenu)	77
Warning and Error Displays	19	SWASH AFR (swashplate surface direction and travel correction) (not in SWH1)	79
AIRPLANE (ACRO) FUNCTIONS	20	Setting up the Normal Flight Condition	81
Map of Functions	21	THR-CUT (specialized settings for helicopter specific models)	82
Quick Guide to Setting up a 4-channel Airplane	22	HELI-SPECIFIC ADVANCE MENU FUNCTIONS	83
ACRO BASIC MENU FUNCTIONS	25	THROTTLE HOLD	83
MODEL Submenu: MODEL SELECT, COPY and NAME	25	THR-CURVE, PIT-CURVE and REVO.	84
PARAMETER Submenu: TYPE, MODUL, ATL, AIL2,		Idle-ups	85
& RESET	28	Trims/offset	86
Servo REVERSE	31	Delay	87
END POINT	32	Hovering setups	88
Idle Management: IDLE DOWN and THR-CUT	33	Gyros and governors	89
Dual/Triple Rates and Exponential (D/R,EXP)	35	Glossary	94
TIMER Submenu	38		
Auxiliary Channel assignments and			
CH9 reverse (AUX-CH)	39		
TRAINER	40		
TRIM and SUB-TRIM	41		
SERVO Display	42		
Fail Safe and Battery FailSafe (F/S)	43		
ACRO ADVANCE MENU FUNCTIONS	44		
Wing types	44		
FLAPERON	45		
FLAP TRIM	46		
Aileron Differential (AIL-DIFF)	47		
Using a 5-channel receiver: AIL-2	47		
ELEVON (see tail types)	48		
Tail types	48		
ELEVON	48		
Twin Elevator Servos (AILEVATOR)	49		
V-TAIL	50		
SNAP ROLL	51		
Mixes: definitions and types	53		
ELEV-FLAP	54		
AIRBRAKE/BUTTERFLY (crow)	55		
THROTTLE-NEEDLE	56		
THROTTLE DELAY	57		
Linear, Prog. mixes 1-5	59		
Curve, Prog. mixes 6-7	62		

*Note that in the text of this manual, beginning at this point, any time we are using a feature's specialized name or abbreviation, as seen on the screen of the 9C, that name, feature, or abbreviation will be exactly as seen on the radio's screen, including capitalization and shown in a **DIFFERENT TYPE STYLE** for clarity. Any time we mention a specific control on the radio itself, such as moving **SWITCH A**, **KNOB VR(B)**, or the **THROTTLE STICK**, those words will be displayed as they are here.*

INTRODUCTION

Thank you for purchasing a Futaba® 9C series digital proportional R/C system. This system is extremely versatile and may be used by beginners and pros alike. In order for you to make the best use of your system and to fly safely, please read this manual carefully. If you have any difficulties while using your system, please consult the manual, our online Frequently Asked Questions (on the web pages referenced below), your hobby dealer, or the Futaba Service Center.

Owner's Manual and Additional Technical Help

This manual has been carefully written to be as helpful to you, the new owner, as possible. There are many pages of setup procedures and examples. However, it need not be your sole resource of setup guidelines for your 9C. For example, pages 22-24 include setup instructions for a basic 4-channel airplane. The Frequently Asked Questions web page referenced below includes this type of step-by-step setup instructions for a variety of other model types, including multi-engine, complex gear installation, 7-servo aerobatic models, 140 degree CCPM, etc.

Due to unforeseen changes in production procedures, the information contained in this manual is subject to change without notice.

Support and Service: It is recommended to have your Futaba equipment serviced annually during your hobby's "off season" to ensure safe operation.

IN NORTH AMERICA

Please feel free to contact the Futaba Service Center for assistance in operation, use and programming. Please be sure to regularly visit the 9C Frequently Asked Questions web site at www.futaba-rc.com/faq/faq-9c.html. This page includes extensive programming, use, set up and safety information on the 9C radio system and is updated regularly. Any technical updates and US manual corrections will be available on this web page. If you do not find the answers to your questions there, please see the end of our F.A.Q. area for information on contacting us via email for the most rapid and convenient response.

Don't have Internet access? Internet access is available at no charge at most public libraries, schools, and other public resources. We find internet support to be a fabulous reference for many modelers as items can be printed and saved for future reference, and can be accessed at any hour of the day, night, weekend or holiday. If you do not wish to access the internet for information, however, don't worry. Our support teams are available Monday through Friday 8-5 Central time to assist you.

FOR SERVICE ONLY:

Futaba Service Center
1610 Interstate Drive
Champaign IL 61822
www.hobbyservices.com

FOR SUPPORT :

(PROGRAMMING AND USER QUESTIONS)

Please start here for answers to most questions:

www.futaba-rc.com/faq/faq-9c.html

FACSIMILE: 217-398-7721

PHONE: 217-398-8970 option 4

OUTSIDE NORTH AMERICA

Please contact your Futaba importer in your region of the world to assist you with any questions, problems or service needs.

Please recognize that all information in this manual, and all support availability, is based upon the systems sold in North America only. Products purchased elsewhere may vary. Always contact your region's support center for assistance.

Application, Export, and Modification

1. This product may be used for model airplane or surface (boat, car, robot) use, if on the correct frequency. It is not intended for use in any application other than the control of models for hobby and recreational purposes. The product is subject to regulations of the Ministry of Radio/Telecommunications and is restricted under Japanese law to such purposes.

2. Exportation precautions:

(a) When this product is exported from the country of manufacture, its use is to be approved by the laws governing the country of destination which govern devices that emit radio frequencies. If this product is then re-exported to other countries, it may be subject to restrictions on such export. Prior approval of the appropriate government authorities may be required. If you have purchased this product from an exporter outside your country, and not the authorized Futaba distributor in your country, please contact the seller immediately to determine if such export regulations have been met.

(b) Use of this product with other than models may be restricted by Export and Trade Control Regulations, and an application for export approval must be submitted. In the US, use of 72MHz (aircraft only), 75MHz (ground models only) and 27MHz (both) frequency bands are strictly regulated by the FCC. This equipment *must not* be utilized to operate equipment other than radio controlled models. Similarly, other frequencies (except 50MHz, for HAM operators) must ***not*** be used to operate models.

3. Modification, adjustment, and replacement of parts: Futaba is not responsible for unauthorized modification, adjustment, and replacement of parts on this product. Any such changes may void the warranty.

The Following Statement Applies to the Receiver (for U.S.A.)

This device complies with part 15 of the FCC rules. Operation is subject to the following two conditions:

- (1) This device may not cause harmful interference, and
- (2) This device must accept any interference received, including interference that may cause undesirable operation.



(for USA)

The RBRC™ SEAL on the nickel-cadmium battery contained in Futaba products indicates that Futaba Corporation of America is voluntarily participating in an industry-wide program to collect and recycle these batteries at the end of their useful lives, when taken out of service within the United States. The RBRC™ program provides a convenient alternative to placing used nickel-cadmium batteries into the trash or municipal waste system, which is illegal in some areas.

You may contact your local recycling center for information on where to return the spent battery. Please call 1-800-8-BATTERY for information on Ni-Cd battery recycling in your area. Futaba Corporation of America's involvement in this program is part of its commitment to protecting our environment and conserving natural resources.

NOTE: Our instruction manuals encourage our customers to return spent batteries to a local recycling center in order to keep a healthy environment.

RBRC is a trademark of the Rechargeable Battery Recycling Corporation.

Meaning of Special Markings

Pay special attention to safety where indicated by the following marks:

- ⚠ **DANGER** - Procedures which may lead to dangerous conditions and cause death/serious injury if not carried out properly.
- ⚠ **WARNING** - Procedures which may lead to a dangerous condition or cause death or serious injury to the user if not carried out properly, or procedures where the probability of superficial injury or physical damage is high.
- ⚠ **CAUTION** - Procedures where the possibility of serious injury to the user is small, but there is a danger of injury, or physical damage, if not carried out properly.

⊘ = Prohibited ⓘ = Mandatory

Warning: Always keep electrical components away from small children.

FLYING SAFETY

To ensure the safety of yourself and others, please observe the following precautions:

- ⓘ **Have regular maintenance performed.** Although your 9C protects the model memories with non-volatile EEPROM memory (which does not require periodic replacement) and not a battery, it still should have regular checkups for wear and tear. We recommend sending your system to the Futaba Service Center annually during your non-flying-season for a complete checkup and service.

Ni-Cd Battery

- ⓘ **Charge the batteries!** (See Charging the Ni-Cd batteries, p. 14, for details.) Always recharge the transmitter and receiver batteries for at least 8 hours before each flying session. A low battery will soon die, causing loss of control and a crash. When you begin your flying session, reset your 9C's built-in timer, and during the session pay attention to the duration of usage.
- ⓘ **Stop flying long before your batteries become low on charge. Do *not* rely on your radio's low battery warning systems, intended only as a precaution, to tell you when to recharge. Always check your transmitter *and* receiver batteries prior to each flight.**

Where to Fly

We recommend that you fly at a recognized model airplane flying field. You can find model clubs and fields by asking your nearest hobby dealer, or in the US by contacting the Academy of Model Aeronautics.

You can also contact the national Academy of Model Aeronautics (AMA), which has more than 2,500 chartered clubs across the country. Through any one of them, instructor training programs and insured newcomer training are available. Contact the AMA at the address or toll-free phone number below.



Academy of Model Aeronautics
5151 East Memorial Drive
Muncie, IN 47302-9252
Tele. (800) 435-9262
Fax (765) 741-0057
or via the Internet at <http://www.modelaircraft.org>

- ❗ **Always pay particular attention to the flying field's rules**, as well as the presence and location of spectators, the wind direction, and any obstacles on the field. Be very careful flying in areas near power lines, tall buildings, or communication facilities as there may be radio interference in their vicinity.

If you must fly away from a club field, be sure there are no other modelers flying within a **three-to-five-mile range**, or you may lose control of your aircraft or cause someone else to lose control.

At the flying field

- ❗ **Before flying, be sure that the frequency you intend to fly with is not in use**, and secure any frequency control device (pin, tag, etc.) for that frequency before turning on your transmitter. **It is never possible to fly two or more models on the same frequency at the same time.** Even though there are different types of modulation (AM, FM, PCM), only one model may be flown on a single frequency at any one time.
- ❗ To prevent possible damage to your radio gear, turn the power switches on and off in the proper sequence:
 1. Pull throttle stick to idle position, or otherwise disarm your motor/engine.
 2. Turn on the transmitter power and allow your transmitter to reach its home screen.
 3. Confirm the proper model memory has been selected.
 4. Fully extend the transmitter antenna.
 5. Turn on your receiver power.
 6. Test all controls. If a servo operates abnormally, don't attempt to fly until you determine the cause of the problem. *(For PCM systems only: Test to ensure that the FailSafe settings are correct by waiting at least 2 minutes after adjusting them, turning the transmitter off and confirming the proper surface/throttle movements. Turn the transmitter back on.)*
 7. Start your engine.
 8. Complete a full range check (see p. 17).
 9. After flying, bring your throttle stick to idle position, engage any kill switches or otherwise disarm your motor/engine.
 10. Turn off receiver power.
 11. Turn off transmitter power.

If you do not turn on your system in this order, you may damage your servos or control surfaces, flood your engine, or in the case of electric-powered or gasoline-powered models, the engine may unexpectedly turn on and cause a severe injury.

- ❗ **While you are getting ready to fly, if you place your transmitter on the ground, be sure that the wind won't tip it over.** If it is knocked over, the throttle stick may be accidentally moved, causing the engine to speed up. Also, damage to your transmitter may occur.

- ❗ **Before taxiing, be sure to extend the transmitter antenna to its full length.**

A collapsed antenna will reduce your flying range and cause a loss of control. It is a good idea to avoid pointing the transmitter antenna directly at the model, since the signal is weakest in that direction.

- ❗ **Don't fly in the rain!** Water or moisture may enter the transmitter through the antenna or stick openings and cause erratic operation or loss of control. If you must fly in wet weather during a contest, be sure to cover your transmitter with a plastic bag or waterproof barrier. Never fly if lightning is expected.

A QUICK INTRODUCTION TO THE 9C SYSTEM

*Note that in the text of this manual, beginning at this point, any time we are using a feature's specialized name or abbreviation as seen on the screen of the 9C, that name, feature, or abbreviation will be exactly as seen on the radio's screen, including capitalization and shown in a **DIFFERENT TYPE STYLE** for clarity. Any time we mention a specific control on the radio itself, such as moving **SWITCH A**, **KNOB VR(B)**, or the **THROTTLE STICK**, those words will be displayed as they are here.*

TRANSMITTER:

- Large graphic liquid-crystal display panel with 4 buttons and an easy set up turn-and-press Dial for quick, easy setup.
- All transmitters include all 3 aircraft types with specialized programming for each, including:
 - **Airplane (ACRO)**
 - V-tail
 - **ELEVON**
 - **AIRBRAKE**
 - Twin Aileron Servos (**FLAPERON** and **AIL-DIFF**)
 - Twin Elevator Servos (**AILEVATOR**)
 - Snap Roll (4 separate directions available)
 - **Helicopter** (5 swashplate types, including CCPM, see page 77)(**HELI**)
 - 3 Idle Ups
 - Revo. Mixing
 - Delay
 - Throttle and Pitch Curves per Condition
 - Gyro Mixing including Separate Settings per Condition
 - Governor Mixing
 - **Sailplane/Glider** (2 wing types)(**GLID**)
 - V-tail
 - **ELEVON**
 - **START OFFSET**
 - Twin Ailerons (**FLAPERON** and **AIL-DIFF**)
 - Crow (**BUTTERFLY**)
 - **SPEED OFFSET**
- **BASIC** menu for quick, easy set up of less complex models.
- **ADVANCE** menu for more complex, unique setups.
- Four electronic **TRIM LEVERS** for rapid yet precise trim adjustment - no remembering to “store trims” between models and no more “bumped trims” during transport.
- **IDLE- DOWN (ACRO)** and **THR-CUT (ACRO/HELI)** (engine shut off) setups to allow precise engine control for taxi and landings.
- 8 complete model memories with 6 more per optional **CAMPac**.
- New stick design with improved feel, adjustable length and tension.
- Triple rates available by setting dual rates to 3-position switches.
- Eight **SWITCHES**, 3 **DIALS** and 2 **SLIDERS**; completely assignable in most applications.
- Trainer system includes the “functional” (**FUNC**) setting, which allows the student to use the 9C's mixing, helicopter, and other programming functions even with a 4-channel buddy box. (Optional trainer cord required.)
- Transmits in both FM (**PPM**) and **PCM** by selecting modulation/cycling transmitter. Requires receiver of proper modulation.
- Permanent memory storage via EEPROM with no backup battery to service or have fail.
- 9CA transmitter features airplane friendly switch layout, with the trainer switch at the left hand, and a notched throttle to minimize throttle changes with rudder input. Defaults to **ACRO MODEL TYPE**.
- 9CH transmitter features helicopter-friendly switch layout, with idle-up and throttle hold switches at the left hand, and a smooth, ratchet-less (unsprung) throttle for perfect hovering. Defaults to **HELI(SW1) MODEL TYPE**.
- Change transmitter mode from mode 2 to modes 1, 3, or 4. (See P. 15)

MODULE: 72TP-FM

- Module may be easily removed and a module on a different channel (or even band) reinserted to change the frequency on which the 9C transmits.
- Module transmits both FM (**PPM**) and **PCM**. No need for a second module.
- All transmission circuitry is included in the module, so no retuning is needed when changing channels or even bands.
- Frequency band is changed by inserting a module on the proper band, including for international or ground model use.
- *In North America* it is against FCC regulation to change **the crystal within the transmitter module** to a different channel. All such transmitter crystal changes must be performed by a certified radio technician. Failure to properly tune a system to its new channel may result in decreased range and may also result in interference to other types of frequency users on adjoining channels. Doing so also voids your AMA insurance.
- The FSS synthesized module for the 9Z family of radios is **NOT** compatible with the 9C.
- Radio system beeps and **RF LIGHT** goes out to indicate module is not installed and radio is not transmitting.
- Non-Futaba brand modules are not FCC certified for use with this radio and therefore are against FCC regulation to use. Doing so also voids your AMA insurance.
- TJ75FM modules may also be used with the 9C for ground use models such as robotics, rocketry, trains, cars, and boats.

RECEIVER: R138/R148/R149

- The R138 or R148 FM 8-channel or the R149 PCM 9-channel receiver included with your system is a high-sensitivity narrow-band dual-conversion receiver.
- Note that your 9C transmitter is capable of transmission on both PPM (FM) and PCM with just a simple programming change and just turning the transmitter off and back on. (See p. 28.)
- Any Futaba narrow band FM receiver (all produced after 1991) on the correct frequency band and frequency may be used with the 9C.
- Any Futaba PCM 1024 receiver on the right frequency band and frequency may be used with the 9C (all 1024 receivers say PCM1024; receivers which say PCM but not 1024 are 512 resolution and not compatible).
- ⊗ NEVER attempt to change a receiver's band by simply changing crystal (IE removing a 72MHz crystal and inserting a 75MHz crystal). A receiver that has a crystal installed from a different frequency band without retuning will **not** receive properly and will have dramatically decreased range.
- *In North America* the receiver included with this system may have its frequency changed by simply changing the crystal as long as it remains in the same half the band. A low band receiver between channels 11 and 35 may be changed to any other channel between 11 and 35 without requiring any tuning. A high band receiver between channels 36 and 60 may similarly be changed. Receivers being changed from a high band channel to a low band or vice versa require proper tuning and service by the Futaba Service Center.

SERVOS

- Please see technical specifications page for specifics on the servos included with your system.
- The included receiver is compatible with all J-plug Futaba servos, including retract, winch, and digital servos.

CONTENTS AND TECHNICAL SPECIFICATIONS

(Specifications and ratings are subject to change without notice.)

Your 9CAP or 9CHP (packaged with a 9-channel PCM receiver), 9CAF or 9CHF (packaged with an 8-channel FM receiver) system includes the following components:

- 9C Transmitter, including RF module¹ (TP)
- R148DF Receiver or R149DP Receiver
- Servos, S3004, S3001 or S9001, with mounting hardware and servo arm assortment
- Switch harness
- Aileron extension cord
- 110V wall charger (North America)
- Frequency Flag

Transmitter T9C

Operating system: 2-stick, 9 channels, PCM1024 system
Transmitting frequency: 50, 72 or 75 MHz bands
Modulation: FM/PPM or PCM, switchable
Power supply: 9.6V NT8S600B Ni-Cd battery
Current drain: 280 mA

Receiver R149DP

(PCM Dual conversion)

Receiving frequency: 50 or 72 MHz bands
Intermediate freq.: 10.7 MHz & 455 kHz
Power requirement: 4.8 - 6.0V Ni-Cd battery
Current drain: 14 mA
Size: 1.28 x 2.17 x 0.82 (32.6 x 55.0 x 20.8 mm)
Weight: 1.22 oz (34.5 g)
Channels: 9

Receiver R148DF

(FM Dual conversion)

Receiving frequency: 50 or 72 MHz bands
Intermediate freq.: 10.7MHz & 455 kHz
Power requirement: 4.8 - 6.0V Ni-Cd battery
Current drain: 14 mA
Size: 1" x 2.2" x .9" (25.4 x 55.8 x 22.9 mm)
Weight: 1.1 oz (31.18 g)
Channels: 8

Servo S9001 (Coreless motor)

Control system: Pulse width control, 1.52 ms neutral
Power requirement: 4.8 - 6.0V (from receiver)
Output torque: 54.2 oz-in(3.9 kg-cm) at 4.8V
Operating speed: 0.22 sec/60 at 4.8V
Size: 1.59 x 0.78 x 1.41 (40.4 x 19.8 x 36 mm)
Weight: 1.69 oz (48 g)

Servo S3001 (Standard, ball-bearing)

Control system: Pulse width control, 1.52 ms neutral
Power requirement: 4.8 - 6.0V (from receiver)
Output torque: 41.7 oz-in (3.0 kg-cm)
Operating speed: 0.22 sec/60
Size: 1.59 x 0.78 x 1.41 (40.4 x 19.8 x 36 mm)
Weight: 1.59 oz (45.1g)

Servo S3004 (Standard, ball-bearing)

Control system: Pulse width control, 1.52 ms neutral
Power requirement: 4.8 - 6.0V (from receiver)
Output torque: 44.4 oz-in (3.2 kg-cm)
Operating speed: 0.23 sec/60
Size: 1.59 x 0.78 x 1.41" (40.4 x 19.8 x 36 mm)
Weight: 1.30 oz (38 g)

¹ Transmitter band may only be changed by changing the module. Contact Futaba Service Center regarding adjustability of receiver band. Band *cannot* be changed by simply changing crystals.

The following additional accessories are available from your dealer. Refer to a Futaba catalog for more information:

- **CAMPac Memory module** - the optional DP-16K CAMPac increases your model storage capability (to 14 models from 8) and allows you to transfer programs to another 9C transmitter. Note that data cannot be transferred to/from any other model of transmitter (i.e. 8U, 9Z, etc).
- ⚠ **Insertion of a CAMPac containing data of a different transmitter type (ex: 9Z) will result in a complete CAMPac data reset and loss of all data.**
- **NT8S Transmitter battery pack** - the (600mAh) transmitter Ni-Cd battery pack may be easily exchanged with a fresh one to provide enough capacity for extended flying sessions.
- **Trainer cord** - the optional training cord may be used to help a beginning pilot learn to fly easily by placing the instructor on a separate transmitter. Note that the 9C transmitter may be connected to another 9C system, as well as to many other models of Futaba transmitters. The 9C transmitter uses the newer rectangular type cord plug. Both new-to-new and new-to-round plug style trainer cords are available.
- **FTA8 Neckstrap** - a neckstrap may be connected to your T9C system to make it easier to handle and improve your flying precision, since your hands won't need to support the transmitter's weight.
- **Y-harnesses, servo extensions, etc** - Genuine Futaba extensions and Y-harnesses, including a heavy-duty version with heavier wire, are available to aid in your larger model and other installations.
- **5-cell (6.0V) receiver battery packs** - All Futaba airborne equipment (except that which is specifically labeled otherwise) is designed to work with 4.8V (Ni-Cd 4 cells) or 6.0V (Ni-Cd 5 cells or alkaline 4 cells). Using a 6.0V pack increases the current flow to the servos, which accelerates their rate of response and their torque. However, because of this faster current draw, a 5-cell battery pack of the same mAh rating will last approximately $\frac{3}{4}$ the time of a 4-cell pack.
- **R309DPS** - Synthesized receiver which can be changed to any 72MHz frequency with the turn of 2 dials, no tuning needed.
- **Gyros** - a variety of genuine Futaba gyros are available for your aircraft or helicopter needs. See p. 64 for aircraft or p. 89 for helicopter gyro information.
- **Governor (GV1)** - for helicopter use. Automatically adjusts throttle servo position to maintain a constant head speed regardless of blade pitch, load, weather, etc. See p. 89 for details.
- **DSC Cord** - allows setup and testing without transmitting. Requires DSC compatible receiver (R149DP or R309DPS) and DSC cord. With Transmitter and Receiver off, plug cord into trainer port then, into receiver battery slot. All programming and setup may be done in this manner without transmitting.
- **TP72FM modules** - additional modules on other frequencies within the 50MHz (licensed operators only) and 72 MHz bands may be purchased to utilize your transmitter with receivers on other frequencies. Additionally, the TK and TJ75MHz modules may be used with the 9C. (See p.8)
- **Receivers** - various models of receivers may be purchased for use in other models. (See p. 8.)

TRANSMITTER CONTROLS – AIRPLANE

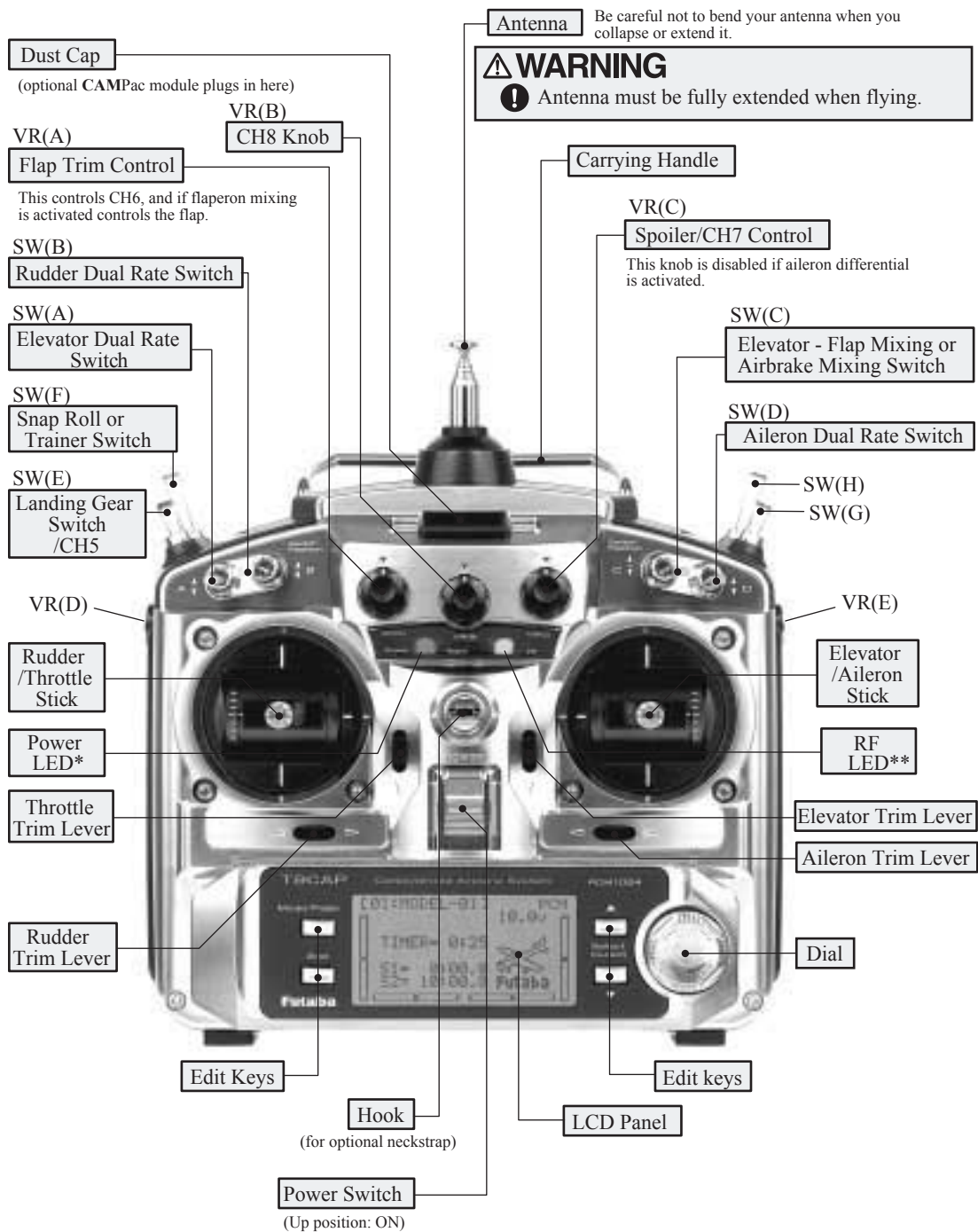

This figure shows the default switch assignments for a Mode 2 system as supplied by the factory. You can change many of the switch positions or functions by selecting a new position within the setting menu for the function you wish to move. (Example: move aileron dual rates to switch C to create triple rates. See p. 35 for details.)

* Power LED blinks to indicate if any mix switches are activated.
 ** RF LED is green when the transmission link is solid and the radio is transmitting properly.

TRANSMITTER CONTROLS – HELI

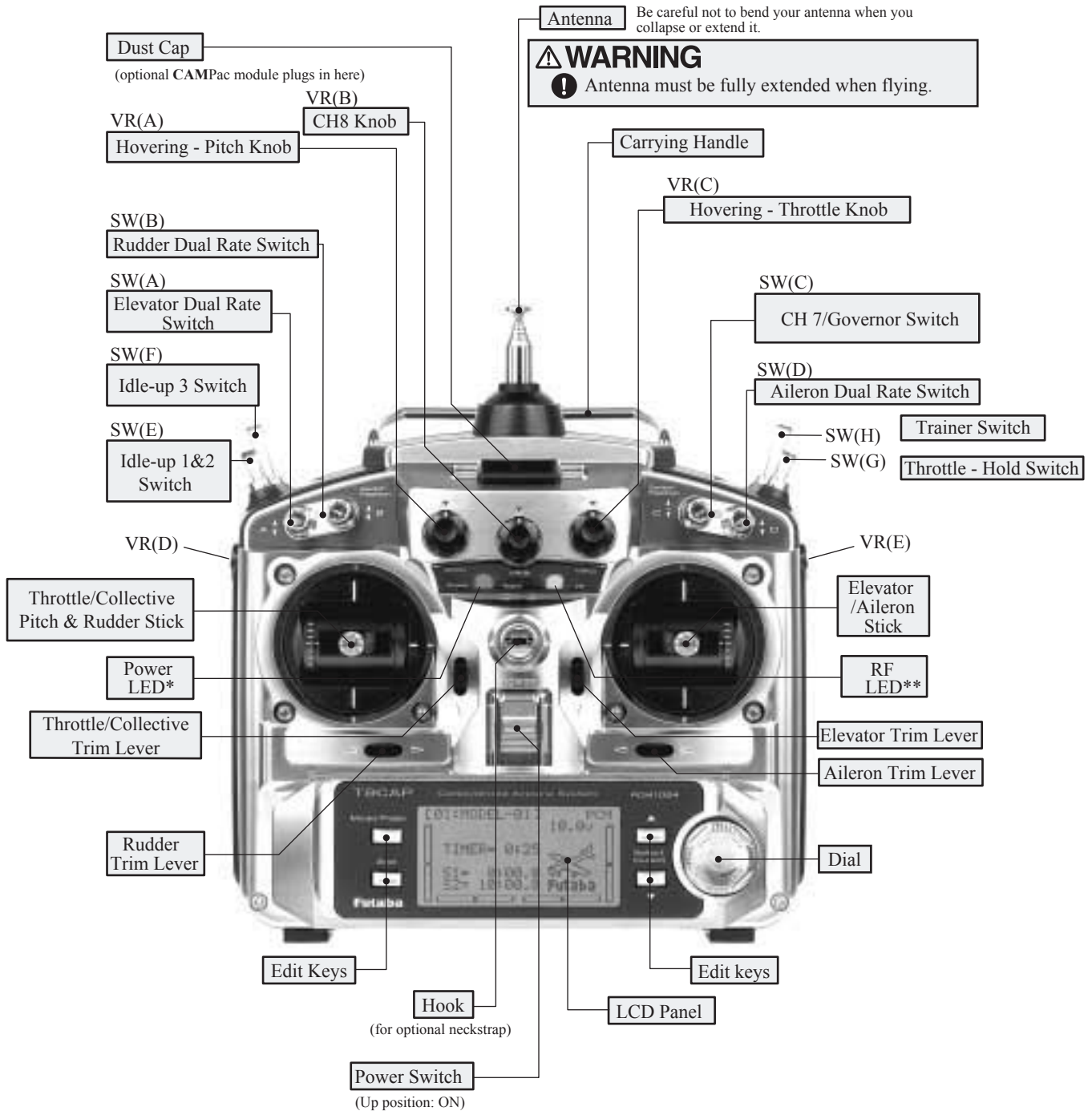

This figure shows the default switch assignments for a Mode 2 system as supplied by the factory. You can change many of the switch positions or functions by selecting a new position within the setting menu for the function you wish to move. (Example: move aileron dual rates to switch C to create triple rates. See p. 35 for details.)

* Power LED blinks to indicate if any mix switches are activated.
 ** RF LED is green when the transmission link is solid and the radio is transmitting properly.

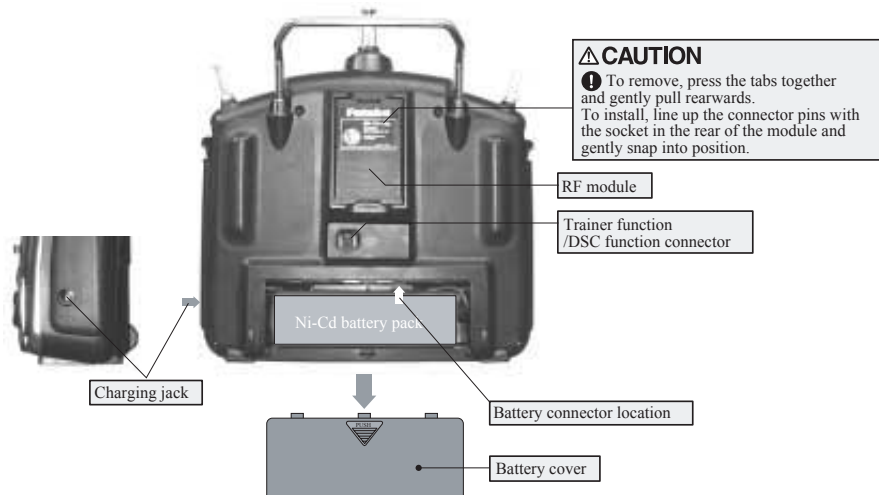

NOTE: If you need to remove or replace the transmitter battery, do not pull on its wires to remove it. Instead, gently pull on the connector's plastic housing where it plugs into the transmitter.

SWITCH ASSIGNMENT TABLE

- The factory default functions activated by the switches and knobs for a Mode 2 transmitter are shown below.
- Most 9C functions may be reassigned to non-default positions quickly and easily.
- Basic control assignments of channels 5-9 are quickly adjustable in **AUX-CH** (see pp. 39). For example, the channel 5 servo, which defaults to **SWITCH E** for retract use, can easily be unassigned (**NULL**) to allow for easy use as a second rudder servo in a mix, or to a slider or dial for bomb door or other control.
- Note that most functions need to be activated in the programming to operate.
- Mode 1 transmitter functions are similar but reverse certain switch commands. Always check that you have the desired switch assignment for each function during set up.

Switch/Knob A or H Tx.	Airplane (ACRO)	Sailplane/Glider (GLID)	Helicopter (HELI)
SWITCH A	elevator dual rate	elevator dual rate down = butterfly on	elevator dual rate
Switch B	rudder dual rate	rudder dual rate	rudder dual rate
Switch C	up = ELE-FLP on center/down = IDLE-DOWN down = AIRBRAKE on	up = ELE-FLP on center/down = IDLE-DOWN	governor/ch 7
SWITCH D	aileron dual rate	aileron dual rate	aileron dual rate
Switch E OR G*	landing gear/ch 5	GLID1FLP = gear	throttle hold
Switch F OF H*	snap roll/trainer	trainer	trainer/ THR-CUT
SWITCH G OR E*	none	back = SPEED OFFSET fwd = START OFFSET	idle-up 1 and 2
SWITCH H OR F*	none	none	idle-up3/ch 5/gyro
KNOB A	flap/ch 6 (flap trim if FLAPERON on)	GLID1FLP : flap (flap trim if FLAPERON on) GLID2FLP : camber (flap trim if FL-AIL off)	HOVERING PITCH
KNOB B	ch 8	ch 8	ch 8
KNOB C	spoiler/ch 7 (disabled if AIL-DIFF on)	spoiler/ch 7 (disabled if AIL-DIF on)	HOVERING THROTTLE
SLIDER D	none	GLID1FLP : ch 5	none
SLIDER E	none	none	none

*On the 9CH transmitters, the **TOP LEFT SWITCHES** are spring-loaded and 3-position; on the 9CA, those switches are on the right side. For consistency, the switch position's designation remains the same (upper left is F, etc), but the functions are moved to match the switch type.

RECEIVER AND SERVO CONNECTIONS

Receiver Output and Channel	Aircraft (ACRO) Glider (GLID1FLP/GLID2FLP)	Helicopter (HELI)
1	ailerons/right aileron ¹ /combined right flap & aileron ¹	aileron (cyclic roll)
2	elevator	elevator (cyclic pitch)
3	throttle	throttle
4	rudder	rudder
5	spare/landing gear/left aileron ^{1,3} /combined left flap and aileron ^{2,3} right flap (GLD2FLP)	spare/gyro
6	spare/ flap(s)/combined left flap and aileron ²	pitch (collective pitch)
7	spare/left aileron ¹	spare/governor
8	spare/second elevator servo ⁴ /mixture control	spare
9	spare	spare

¹Aileron Differential mode (**AIL-DIFF**). (See p. 47).

²Flaperon mode. (See p. 45).

³Using Second Aileron option, second aileron servo output is sent to channels 5 and 6 to allow use of a 5-channel receiver. (**AIL-2**) (See p. 47)

⁴**AILEVATOR** (dual elevator) mode. (See p. 49).

CHARGING THE Ni-Cd BATTERIES

Charging Your System's Batteries

1. Connect the transmitter charging jack and airborne Ni-Cd batteries to the transmitter and receiver connectors of the charger.
2. Plug the charger into a wall socket.
3. Check that the charger LED lights.

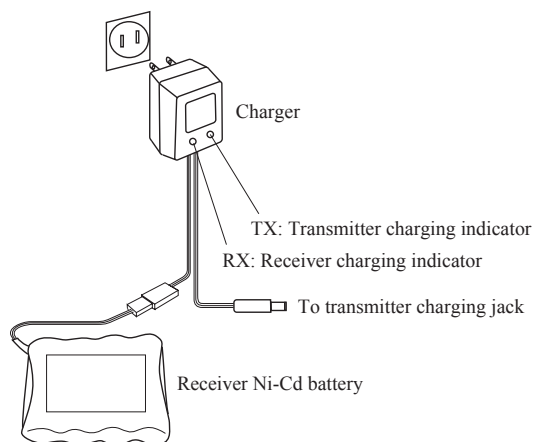

The initial charge, and any charge after a complete discharge, should be at least 18 hours to ensure full charge. The batteries should be left on charge for about 15 hours when recharging the standard NR-4J, NR4F 1500 and NT8S600B Ni-Cd batteries.

We recommend charging the batteries with the charger supplied with your system. Note that the use of a fast charger may damage the batteries by overheating and dramatically reduce their lifetime.

! You should fully discharge your system's Ni-Cd batteries periodically to prevent a condition called memory. For example, if you only make two flights each session, or you regularly use only a small amount of the batteries capacity, the memory effect can reduce the actual capacity even if the battery is fully charged. You can cycle your batteries with a commercial cycling unit*, or by leaving the system on and exercising the servos by moving the transmitter sticks until the transmitter shuts itself off. Cycling should be done every four to eight weeks, even during the winter or periods of long storage. Keep track of the batteries capacity during cycling; if there is a noticeable change, you may need to replace the batteries.

*Note that the 9C transmitter system has electronic protection from overcharging and reverse polarity via a poli-switch. It does NOT have a diode in the charge circuit and may be discharged/peak charged with the battery in the transmitter.

⊘ DO NOT attempt to charge your 8-cell transmitter pack on the 4-cell receiver plug of the wall charger!

Adjusting the length of the non-slip control sticks

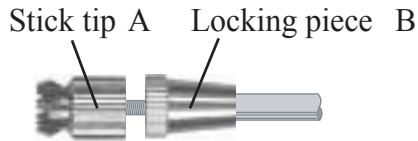

You may change the length of the control sticks to make your transmitter more comfortable to hold and operate. To lengthen or shorten your transmitter's sticks, first unlock the stick tip by holding locking piece B and turning stick tip A counterclockwise. Next, move the locking piece B up or down (to lengthen or shorten). When the length feels comfortable, lock the position by turning locking piece B counterclockwise.

Stick lever tension adjustment

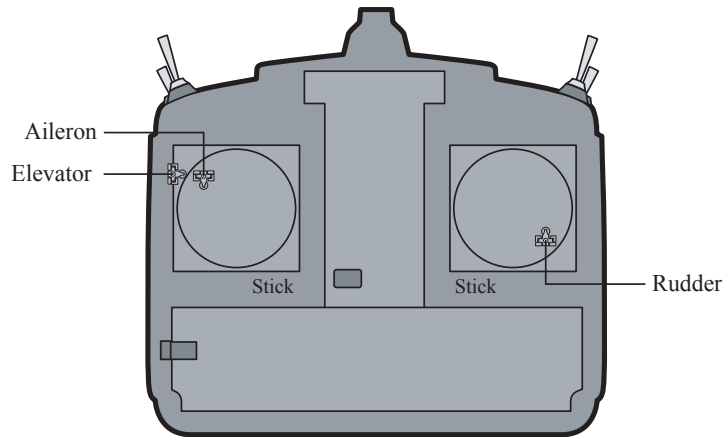

Mode 2 transmitter with rear cover removed.

You may adjust the tension of your sticks to provide the feel that you prefer for flying. To adjust your springs, you'll have to remove the rear case of the transmitter. First, remove the battery cover on the rear of the transmitter. Next, unplug the battery wire, and remove the battery and RF module from the transmitter. While you are removing the RF module, pay attention to the location of the pins that plug into the back of the module. Next, using a screwdriver, remove the four screws that hold the transmitter's rear cover in position, and put them in a safe place. Gently ease off the transmitter's rear cover. Now you'll see the view shown in the figure above.

Using a small Phillips screwdriver, rotate the adjusting screw for each stick for the desired spring tension. The tension increases when the adjusting screw is turned clockwise.

When you are satisfied with the spring tensions, reattach the transmitter's rear cover. Check that the upper printed circuit board is on its locating pins, then very carefully reinstall the rear cover being mindful to guide the RF module connector pins through the slot in the case. When the cover is properly in place, reinstall and tighten the four screws. Reinstall the battery, cover and module.

Adjusting Display Contrast

To adjust the display contrast, from the home menu press and hold the End button.

Turn the dial while still holding the menu button:

clockwise to brighten

counterclockwise to darken the display

Let go of the dial and the button.

To reset to default, Hold the **END** key and press and hold the **Dial**.

Changing Modes:

Hold down the **Mode** and **End** buttons while turning on the Transmitter. The screen reads "STK-MODE". Change this to the correct mode. Note that this will NOT change the throttle and elevator ratchets, etc. Those are mechanical changes that must be done by a service center.

RADIO INSTALLATION

While you are installing the battery, receiver, switch harness and servos into your model's fuselage, please pay attention to the following guidelines:

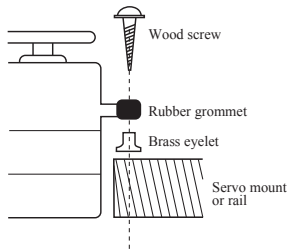

❗ **Use the supplied rubber grommets when you mount each servo. Be sure not to over-tighten the screws.** If any portion of the servo case directly contacts the fuselage or the servo rails, the rubber grommets will not dampen the vibration, which can cause mechanical wear and servo failure.

Servo Throw

❗ **Once you have installed the servos, operate each one over its full travel and check that the pushrod and output arms do not bind or collide with each other, even at extreme trim settings.** Check to see that each control linkage does not require undue force to move (if you hear a servo buzzing when there is no transmitter control motion, most likely there is too much friction in the control or pushrod). Even though the servo will tolerate loads, any unnecessary load applied to the servo arm will drain the battery pack quickly.

Switch Harness Installation

❗ When you are ready to install the switch harness, remove the switch cover and use it as a template to cut screw holes and a rectangular hole slightly larger than the full stroke of the switch. Choose a switch location on the opposite side of the fuselage from the engine exhaust pipe, and pick a location where it can't be inadvertently turned on or off during handling or storage. Install the switch so it moves without restriction and snaps from ON to OFF and vice versa.

Receiver Antenna

It is normal for the receiver antenna to be longer than the fuselage.
❗ **DO NOT cut or fold it back on itself** — cutting or folding changes the electrical length of the antenna and may reduce range. Secure the antenna to the top of the vertical fin, and let the excess wire length trail behind. You may run the antenna inside of a *non-metallic* housing within the fuselage, but range may suffer if the antenna is located near metal or carbon fiber pushrods or cables. Be sure to perform a range check before flying.

Receiver Notes

When you insert servo, switch or battery connectors into the receiver, note that each plastic housing has an alignment tab. Be sure the alignment tab is oriented properly before inserting the connector. To remove a connector from the receiver, pull on the connector housing rather than the wires.

If your aileron servo (or others) are too far away to plug into the receiver, use an aileron extension cord to extend the length of the servo lead. Additional Futaba extension cords of varying lengths are available from your hobby dealer. Always use an extension of the proper length. Avoid plugging multiple extensions together to attain your desired length. If distance is greater than 18" or multiple or high current draw servos are being used, use Futaba Heavy-Duty servo extensions.

Receiver Vibration and Waterproofing

The receiver contains precision electronic parts. Be sure to avoid vibration, shock, and temperature extremes.
❗ **For protection, wrap the receiver in foam rubber or other vibration-absorbing materials.** It is also a good idea to waterproof the receiver by placing it in a plastic bag and securing the open end of the bag with a rubber band before wrapping it with foam rubber. If you accidentally get moisture or fuel inside the receiver, you may experience intermittent operation or a crash. If in doubt, send the receiver for service.

Range Testing Your R/C System

Please note that different systems demonstrate different range checks and the same system will range check differently in different conditions. Also, the receiver antenna's installation affects the range test -- exiting the top of the model is ideal.

This is a brief explanation of range test. For more in-depth specifics on receiver antenna mounting, additional checks if unsatisfactory range is demonstrated, range checking with gasoline powered engines, etc, please see our F.A.Q. page at www.futaba-rc.com.

- Leave the transmitter's antenna retracted and be sure both batteries are fully charged.
- Position the aircraft away from wires, other transmitters, etc.

Test one - engine/motor off, minimum of 100 ft. range

- Have a friend view the model but not hold it, engine off. (People conduct signals, too!)
- Walk away from the model, working all controls constantly. Stop when the servos jitter significantly (a jitter here and there is normal), control movement stops (PCM), or you lose control altogether.
- Measure the distance. If greater than 100 feet, great! Proceed to Test 2. Less than 100 feet of range check means you need more information to determine if your system is safe to fly. Please see our web site or call support for additional tests to perform before flying your system.
- Repeat with friend holding the model. Note any differences.

Test two - engine/motor on

- Repeat the test with the model's engine running and with someone holding the model. If a decrease of more than 10% is noted, research and resolve the cause of interference prior to flying your model.

What your fully operational system demonstrates is the normal range for your system in those conditions. Before every flying session, it is critical that you perform a range check. It is also required by the AMA Safety Code. If you notice a significant decrease in range with fully charged batteries, **do not attempt to fly**.

Aircraft (fixed wing and helicopter) Frequencies

72 MHz band

Ch.	MHz	Ch.	MHz
11	72.010	36	72.510
12	72.030	37	72.530
13	72.050	38	72.550
14	72.070	39	72.570
15	72.090	40	72.590
16	72.110	41	72.610
17	72.130	42	72.630
18	72.150	43	72.650
19	72.170	44	72.670
20	72.190	45	72.690
21	72.210	46	72.710
22	72.230	47	72.730
23	72.250	48	72.750
24	72.270	49	72.770
25	72.290	50	72.790
26	72.310	51	72.810
27	72.330	52	72.830
28	72.350	53	72.850
29	72.370	54	72.870
30	72.390	55	72.890
31	72.410	56	72.910
32	72.430	57	72.930
33	72.450	58	72.950
34	72.470	59	72.970
35	72.490	60	72.990

50 MHz Band (Amateur Radio Operator "HAM" license required)

Ch.	MHz	Ch.	MHz
00	50.800	01	50.820
02	50.840	03	50.860
04	50.880	05	50.900
06	50.920	07	50.940
08	50.960	09	50.980

Installing your frequency number flag:

❗ **It is very important that you display your transmitting channel number at all times.** To install your flag, peel off the channel number's backing sheet, and carefully stick the numbers to both sides of the number holder. Now you can snap the number holder onto the lower portion of the antenna as shown in the figure — use the clip that fits more snugly on your antenna. You may wish to cut off the other, unused clip on the other side of the flag.

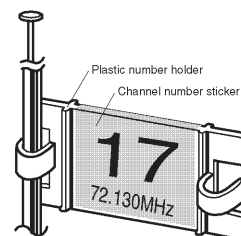

The following frequencies and channel numbers may be used for flying aircraft in the United States:

TRANSMITTER DISPLAYS & BUTTONS

When you first turn on your transmitter, a confirmation double beep sounds, and the screen shown below appears. Before flying, or even starting the engine, **be sure** that the model type and name appearing on the display matches the model that you are about to fly! If you are in the wrong model memory, servos may be reversed, and travels and trims will be wrong, leading to an immediate crash.

Edit buttons and Start-up Screen (appears when system is first turned on):

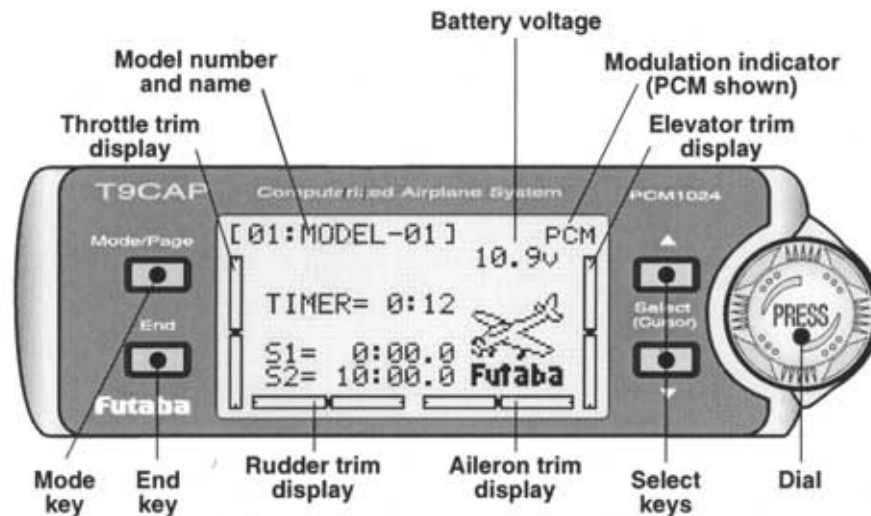



MODE/PAGE BUTTON: (key)



 Press and hold **MODE BUTTON** for one second to open programming menus. Press **MODE BUTTON** to switch between **BASIC** and **ADVANCE** menus.

END BUTTON: (key)

 Press **END BUTTON** to return to previous screen. Closes functions back to menus, closes menus to start-up screen.

SELECT/CURSOR BUTTONS: (key)

  Press **SELECT/CURSOR BUTTON** to scroll through and select the option to edit within a function.

  Press **SELECT/CURSOR BUTTON** to page up/page down within **BASIC** or **ADVANCE** menu.



Turn Dial:

 Turn **DIAL** clockwise or counterclockwise to quickly scroll through functions within each menu.

 Turn **DIAL** clockwise or counterclockwise to scroll through choices within an option of a function (for example, to select which switch controls dual/triple rates).

Press Dial:

 Press **DIAL** to select the actual function you wish to edit from the menu.

 Press **DIAL** and hold one second to confirm major decisions, such as the decision to: select a different model from memory, copy one model memory over another, trim reset, store channel position in FailSafe, change model type, reset entire model. System will ask if you are sure.  Press **DIAL** again to accept change.

WARNING & ERROR DISPLAYS

An alarm or error indication may appear on the display of your transmitter for several reasons, including when the transmitter power switch is turned on, when the battery voltage is low, and several others. Each display has a unique sound associated with it, as described below.

MODEL SELECTION ERROR: Warning sound: 5 beeps (repeated 3 times)

The **MODEL SELECTION** warning is displayed when the transmitter attempts to load a model memory from a memory module (optional CAMPac) that is not currently plugged into the transmitter. When this occurs, model No. 01 is automatically loaded.



```
MODEL SELECT ERROR 1
CURRENT MODEL No.01
```

Do not fly until the proper model is loaded into memory! Reinsert the memory module, and recall the desired setup using the model select function.

LOW BATTERY ERROR: Warning sound: Continuous beep until transmitter is powered off.

The **LOW BATTERY** warning is displayed when the transmitter battery voltage drops below 8.5V.

THIS IS NOT AN “OK TO FLY” to this level! This is a warning that the radio is about to shut off.

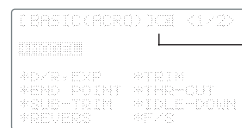

```
ERR01<ACRO>FE <1>2
#####
AD>:EUP *TEH*
*END POINT *THR-OUT
*SLD-TURN *IDLE-DOWN
*REVERS *K<K
```

Land your model as soon as possible before loss of control due to a dead battery.

MIXER ALERT WARNING: Warning sound: 5 Beeps (repeated until problem resolved or overridden)



```
*** WARNING!! ***
SNAP-ROLL
AIR-BRAKE
THR-OUT
THR-OUT
```

The **MIXER ALERT** warning is displayed to alert you whenever you turn on the transmitter with any of the mixing switches active. This warning will disappear when the offending switch or control is deactivated. Switches for which warnings will be issued at power-up are listed below:

ACRO:Throttle cut, idle-down, snap roll, airbrake **GLID:**Butterfly, Start and Speed mixing **HELI:**Throttle cut, throttle hold, idle-up

If turning a switch OFF does not stop the mixing warning: When the warning does not stop even when the mixing switch indicated by the warning display on the screen is turned off, the functions described previously probably use the same switch and the OFF direction setting is reversed. In short, one of the mixings described above is not in the OFF state. In this case, reset the warning display by pressing both **SELECT BUTTONS** simultaneously. Then change one of the switch settings of the mixings duplicated at one switch.

BACKUP ERROR: Warning sound: 4 beeps (repeated continuously)

The **BACKUP ERROR** warning occurs when the transmitter memory is lost for any reason. If this occurs, all of the data will be reset when the power is turned on again.

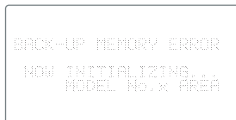

```
BACK-UP MEMORY ERROR
NOW INITIALIZING
MODEL No.1 AREA
```

Do not fly when this message is displayed — all programming has been erased and is not available. Return your transmitter to Futaba for service.

MEMORY MODULE INITIALIZE DISPLAY

This warning appears when an (optional) CAMPac memory module is used in the transmitter for the first time. When the **MODE BUTTON** is pressed, initialization of the module begins, after which the memory module can be used. Once the module is initialized, the display will not appear again.

⊗ **The 9C CANNOT convert data from other radio types (ie. 8U, 9Z). Installation of a CAMPac with data from another radio type will result in reinitialization of the CAMPac and loss of all data.**

RF MODULE WARNING: Warning sound: A single long beep. The single beep lets you know that the RF module has been removed from the transmitter, or is not being read properly. The green RF light also goes out.

AIRCRAFT (ACRO) MENU FUNCTIONS

Please note that all **BASIC** menu functions are the same for airplanes (**ACRO**), sailplanes (**GLID1FLP/2FLP**), and helicopters (**HELISWH1/SWH2/SWH4/SR-3/SN-3**). The glider **BASIC** menu does not include **IDLE-DOWN** or **THR-CUT**; the helicopter **BASIC** menu includes additional features (swashplate adjustment and throttle/pitch curves and revo for Normal flight mode) that are discussed in the Helicopter section.

Map of ACRO BASIC functions21
Quick Guide to Setting up a 4-channel Airplane22
ACRO BASIC MENU FUNCTIONS25
MODEL Submenu: MODEL SELECT , COPY and NAME25
PARAMETER Submenu: TYPE , MODUL , ATL , AIL2 , & RESET28
Servo REVERSE31
END POINT32
Idle Management: IDLE DOWN and THR-CUT33
Dual/Triple Rates and Exponential (D/R,EXP)35
TIMER Submenu38
Auxiliary Channel assignments and CH9 reverse (AUX-CH)39
TRAINER40
TRIM and SUB-TRIM41
SERVO Display42
Fail Safe and Battery FailSafe (F/S)43
ACRO ADVANCE MENU FUNCTIONS44
Wing types44
FLAPERON45
FLAP TRIM46
Aileron Differential (AIL-DIFF)47
Using a 5-channel receiver: AIL-247
ELEVON (see tail types)48
Tail types48
ELEVON48
Twin Elevator Servos (AILEVATOR)49
V-TAIL50
SNAP ROLL51
Mixes: definitions and types53
ELEV-FLAP54
AIRBRAKE/BUTTERFLY (crow)55
THROTTLE-NEEDLE56
THROTTLE DELAY57
Linear, Prog. mixes 1-559
Curve, Prog. mixes 6-762

MAP OF ACRO BASIC FUNCTIONS

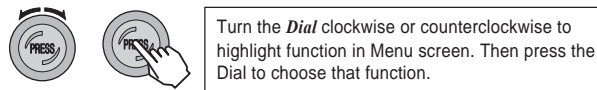
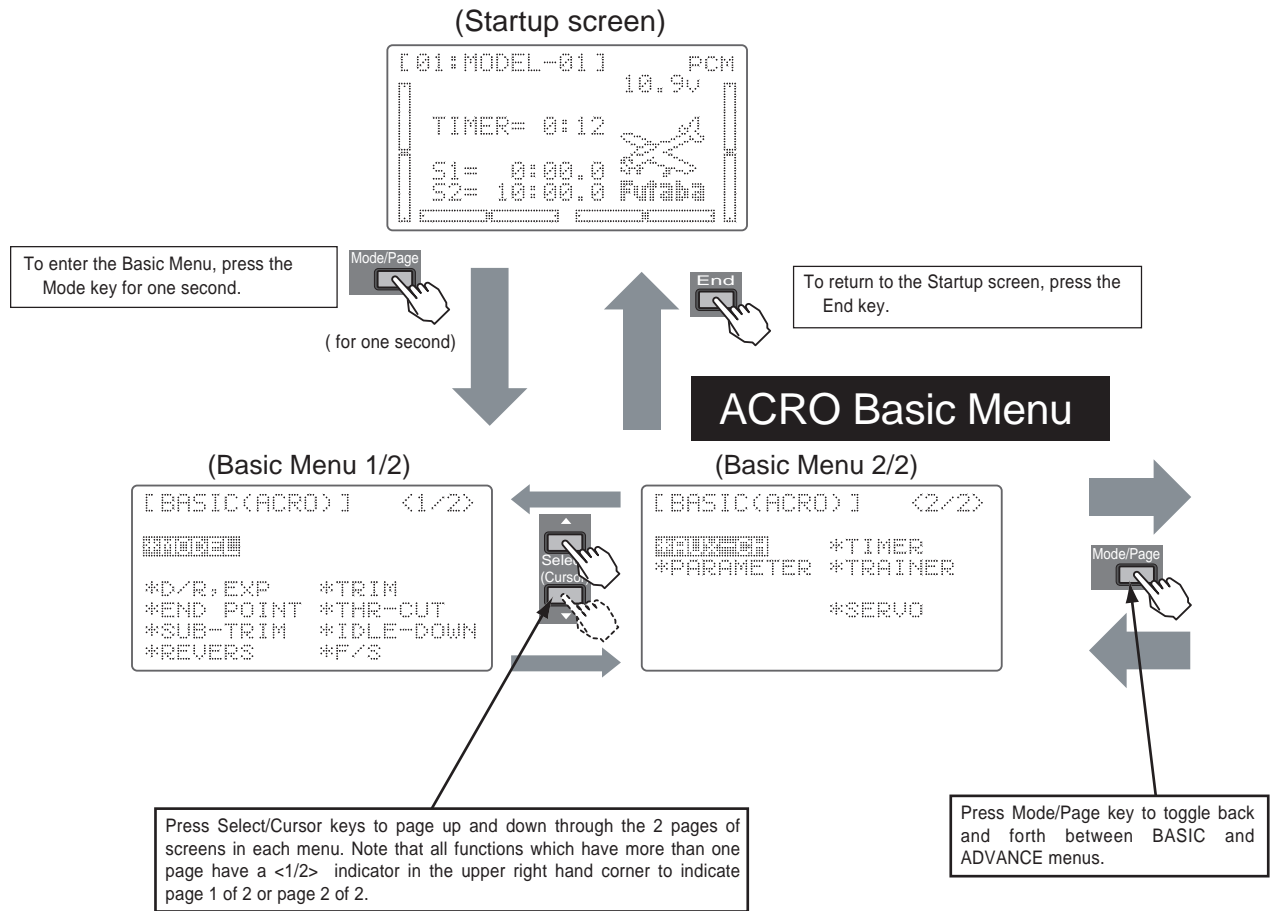

Mode/Page Select

Dial Right or Left

Stick Up

End Selection

Press Button

Stick Right

Cursor Down

Switch Up

Stick Down

Cursor Up

Switch at Center

Stick Left

Dial Left

Switch Down

Turn Knob Right

Dial Right

Turn Knob Left

A QUICK GUIDE: GETTING STARTED WITH A BASIC 4-CHANNEL AIRCRAFT

This guide is intended to help you get acquainted with the radio, to give you a jump start on using your new radio, and to give you some ideas and direction in how to do even more than you may have already considered. It follows our basic format of all programming pages: a big picture overview of what we accomplish; a “by name” description of what we're doing to help acquaint you with the radio; then a step-by-step instruction to leave out the mystery when setting up your model.







For additional details on each function, see that function's section in this manual. The page numbers are indicated in the goals column as a convenience to you.

See p.21 for a legend of symbols used.

GOALS of EXAMPLE	STEPS	INPUTS for EXAMPLE
Prepare your aircraft.	Install all servos, switches, receivers per your model's instructions. Turn on transmitter then receiver; adjust all linkages so surfaces are nearly centered. Mechanically adjust all linkages as close as possible to proper control throws. Check servo direction. Make notes now of what you will need to change during programming.	
Name the model. P. 25. <i>[Note that you do not need to do anything to "save" or store this data. Only critical changes such as a MODEL RESET require additional keystrokes to accept the change.]</i>	Open the BASIC menu, then open the MODEL submenu.	Turn on the transmitter. for 1 second. (If ADVANCE , again.) as needed to highlight MODEL . to choose MODEL .
	Go to MODEL NAME .	to NAME . (First character of model's name is highlighted.)
	Input aircraft's name. Close the MODEL submenu.	to change first character. When proper character is displayed, to move to next character. Repeat as needed. to return to BASIC menu.
Reverse servos as needed for proper control operation. P. 31.	In the BASIC menu, open (servo) REVERSE .	4 steps to REVERSE . to choose REVERSE .
	Choose desired servo and reverse its direction of travel. (Ex: reversing rudder servo.)	to CH4: RUDD . so REV is highlighted. Repeat as needed.
Adjust Travels as needed to match model's recommended throws (usually listed as high rates). P. 32.	From BASIC menu, choose END POINT .	2 steps to END POINT . to choose END POINT .
	Adjust the servo's end points. (Ex: throttle servo) Close the function.	to THROTTLE . THROTTLE STICK . until carb barrel closes as desired. THROTTLE STICK . until throttle arm just opens carb fully at full THROTTLE STICK . Repeat for each channel as needed.

With digital trims you don't shut the engine off with **THROTTLE TRIM**. Let's set up **IDLE-DOWN** and "throttle cut" (**THR-CUT**) now.

GOALS of EXAMPLE	STEPS	INPUTS for EXAMPLE
<p>Set up IDLE-DOWN. P. 33.</p> <p>IDLE-DOWN slows the engine's idle for landings, sitting on the runway, and maneuvers such as spins. The normal (higher idle) setting (when IDLE-DOWN is off) is for engine starting, taxi, and most flight maneuvers, to minimize chance of a flame-out.</p>	<p>From the BASIC menu, choose IDLE-DOWN.</p>	<p> 5 steps to IDLE-DOWN. to choose IDLE-DOWN.</p>
	<p>Activate and adjust IDLE-DOWN.</p>	<p> to OFF. C to center position. Screen now reads ON. to RATE. to increase rate until engine idles reliably but low enough to sit still.</p>
	<p><i>Optional: change switch command from C center-and-down to any other switch.</i> Close the Function.</p>	<p>(<i>Not needed in this example.</i>) </p>
<p>THR-CUT shuts the engine off completely with the flip of a switch. P. 33.</p> <p>(NOTE: DO NOT assign IDLE-DOWN and THR-CUT to both positions of a 2-position switch. See IDLE-DOWN for details.)</p>	<p>From the BASIC menu, choose THR-CUT.</p>	<p> to THR-CUT. to choose THR-CUT.</p>
	<p>Activate, assign SWITCH and adjust. Close the function.</p>	<p> to OFF. to SW. to C. to POSI. to DOWN. to RATE. C to down position. THROTTLE STICK. until throttle barrel closes completely. </p>
<p>Set up dual/triple rates and exponential (D/R,EXP). P. 38.</p> <p>(Note that in the middle of the left side of the screen is the name of the channel AND the switch position you are adjusting. Two or even THREE rates may be set per channel by simply choosing the desired switch and programming percentages with the switch in each of its 2 or 3 positions.)</p>	<p>From the BASIC menu, choose D/R,EXP.</p>	<p> 5 steps to D/R,EXP. to choose D/R,EXP.</p>
	<p>Choose the desired control, and set the first (Ex: high) rate throws and exponential.</p>	<p> A to up position. to CH. to choose CH>2 (elevator). [note the screen reads ELEV (UP)] to D/R. ELEVATOR STICK. to set desired "UP" percentage. ELEVATOR STICK. as needed to adjust "DOWN" percentage (normally set the same as down.) to EXP. ELEVATOR STICK. to set. ELEVATOR STICK. to set.</p>

GOALS of EXAMPLE	STEPS	INPUTS for EXAMPLE
	Set the second (<i>low</i>) rate throws and exponential.	 <i>A</i> to down position.  to D/R . Repeat steps above to set low rate.
	<i>Optional: change dual rate switch assignment. Ex: elevator to switch G (9CA) or E (9CH) with 3 positions.</i>	 to SW .  to G or E .  G or E to center position. Repeat steps above to set 3rd rate.  
<i>Where next?</i>	<i>(Other functions you may wish to set up for your model.)</i> TRAINER p. 40. Multiple wing and/or tail servos: see wing types and tail types, p. 44, 48. Elevator-to-flap, Rudder-to-aileron, flap-to-elevator, and other programmable mixes p. 53. Retractable Gear, Flaps on a Switch, Smoke systems, kill switches, and other auxiliary channel setups. p. 39.	



A LOOK AT THE RADIO'S FUNCTIONS STEP BY STEP

MODEL submenu: includes three functions that manage model memory: **MODEL SELECT**, **MODEL COPY** and **MODEL NAME**. Since these functions are all related, and are all *basic* features used with most models, they are together in the **MODEL** submenu of the **BASIC** menu.

```
[MODEL]
SELECT▶ [MODEL-01]
COPY▶ 1▶ 1 [MODEL-01]
NAME▶ MODEL-01
```

MODEL SELECT: This function selects which of the 8 model memories in the transmitter (or 6 in the optional **CAMPac**) to set up or fly. For clarity the model's name and an image of its type are indicated after its number. (Each model memory may be of a different model type from the other memories.)





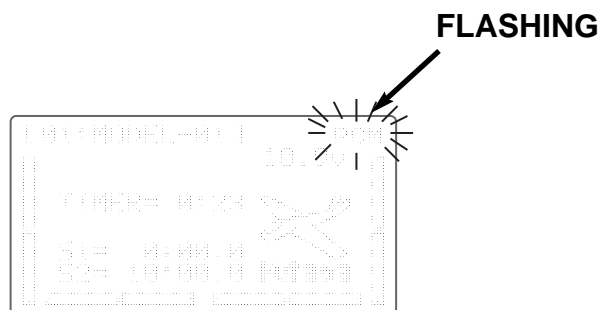

Model type

✧ACRO (aircraft) 
 ✧GLID (glider) 
 ✧HELI (helicopter) 

Note: If you are using the optional **CAMPac**, your choices in **MODEL SELECT** and **MODEL COPY** will include 9-14, which are the model memories in the **CAMPac**. You *do not* have to **COPY** from the **CAMPac** to the transmitter prior to working with that model memory.

NOTE: When you choose a new model in the **MODEL SELECT** function, if the new model is set to the other modulation, you must cycle the transmitter power to change modulations. If you do not cycle the power, the modulation type will flash on the home screen to remind you. You are still transmitting on the other modulation until you affect this change.



GOAL:	STEPS:	INPUTS:
Select Model #3. <i>NOTE: This is one of several functions for which the radio requires confirmation to make a change.</i>	Open BASIC menu, then open MODEL submenu. Choose Model #3. Confirm your change. Close.	MODE for 1 second. (If ADVANCE , MODE again.)  if required to MODEL .   to 3 .  for 1 second. sure? displays.   
Confirm proper modulation of new model memory.	If PPM or PCM are flashing in the upper right hand corner, then the new model is set for the other receiver type. Turn the transmitter off/on to change the modulation.	
<i>Where next?</i>	NAME the model: see p. 25. Change MODEL TYPE (aircraft, heli, glider): see p. 28. Change modulation [FM (PPM) or PCM]: see p. 28. Utilize servo REVERSE : see p. 31. Adjust END POINTS : see p. 32. Set up IDLE-DOWN and THR-CUT for throttle management: see p. 33.	

MODEL COPY: copies the current model data into another model memory (in the transmitter or the optional DP-16K CAMPac). The name of the model memory you are copying *into* is displayed for clarity.

```
[MODEL]
SELECT▶ 1
COPY▶ 1▶ [MODEL-01]
NAME▶ MODEL-01
```

Notes:

- Any data in the model copied *to* will be written over and lost, including name, type and modulation. It *cannot* be recovered.
- To copy from one 9C to another, use an optional **CAMPac**. (Note: The model may be flown directly off the **CAMPac**'s memory, not requiring re-copying into the 2nd transmitter. For more information on **CAMPacs**, please see p. 10.)
- With the trainer **FUNC** mode it is *not* necessary to have the student radio contain the setup of the aircraft. See **TRAINER**, p. 40.

⚠ Data cannot be converted from 8U or 9Z memory types. If a **CAMPac** is installed into the 9C that has data on it from another radio type, it will have to be re-initialized *which deletes all data*.

Examples:

- Start a new model that is similar to one you have already programmed.
- Copy the current model data into another model memory as a backup or before experimenting with new settings.
- Store your model data to an optional **CAMPac** prior to sending your radio for service.
- Edit a copy of your model's data to fly the model in different conditions (ie. Helicopter using heavier night blades; glider in extreme wind; airplane model at extreme altitudes).
- Store your model data to an optional **CAMPac** to use or copy the settings into a friend's 9C (A or H) transmitter so he can fly your model or use it as a starting point for setting up a similar model.

GOAL of EXAMPLE:	STEPS:	INPUTS:
Copy model 3 into model 5. <i>NOTE: This is one of several functions for which the radio requires confirmation to make a change.</i>	Open the BASIC menu, then open MODEL submenu.	for 1 second. (If ADVANCE , again.) to MODEL .
	Confirm you are currently using the proper model memory. (Ex: 3)	If SELECT does not indicate 3, use MODEL SELECT , p. 25.
	Go to MODEL COPY and choose the model to copy <i>into</i> . (Ex: 5)	to 5 .
	<i>Confirm your change.</i>	for 1 second. sure? displays. *
	Close.	
<i>Where next?</i>	SELECT the copy you just made: see p. 25. Rename it (it is currently named <i>exactly</i> the same as the model copied): see p. 25. Turn off the transmitter and remove the CAMPac for safekeeping or insertion into another radio to fly.	

*Radio emits a repeating "beep" and shows progress on screen as the model memory is being copied. Note that if the power switch is turned off prior to completion, the data will not be copied.

MODEL NAME: assigns a name to the current model memory. By giving each model a name that is immediately recognizable, you can quickly select the correct model, and minimize the chance of flying the wrong model memory which could lead to a crash.

```
[MODEL ]
SELECT▶ 1 [MODEL-01 <2>]
COPY▶ 1→ 1 [MODEL-01 <2>]
NAME▶MODEL-01
```

Adjustability and values:

- Up to 8 characters long.
- Each character may be a letter, number, blank, or a symbol.
- The default names assigned by the factory are in MODEL-xx format (**MODEL-01** for first model memory, etc.)

NOTE: When you **COPY** one model memory over another, **everything** is copied, including the model's name. Similarly, if you change **MODEL TYPE** or do a **MODEL RESET**, the entire memory is reset, including MODEL NAME. So the first thing you will want to do after you **COPY** a model, change its type, or start from scratch, is rename the new copy to avoid confusion.

If using multiple frequency modules to be able to transmit on multiple channels, we recommend using the last 2 characters to indicate the receiver's channel for clarity. *For more information on frequency transmission, see p. 8.*

GOAL of EXAMPLE:	STEPS:	INPUTS:
Name model 3 “Cap-232_” (where the underline represents a blank space.)	Open MODEL submenu.	for 1 second. (If ADVANCE , again.) to MODEL .
	Confirm you are currently using the proper model memory. (Ex: 3)	If SELECT does not indicate 3, perform MODEL SELECT , p. 25.
	Go to NAME and change the first character. (Ex: M to C)	to C .
	Choose the next character to change.	
	Repeat the prior steps to complete naming the model.	to a (<i>note: lower case is available</i>) Repeat.
	Close.	
<i>Where next?</i>	Change the MODEL TYPE to glider or helicopter: see p. 28. Change the receiver modulation setting from PPM to PCM or vice versa: see p. 28. Utilize servo REVERSE : see p. 31. Adjust servo travel with END POINT : see p. 32. Set up dual/triple rates and exponential (D/R,EXP): see p. 35.	

PARAMETER submenu: sets those parameters you would likely set once, and then not disturb again.

Once you have selected the correct model you wish to work with, the next step is setting up the proper parameters for this specific model:

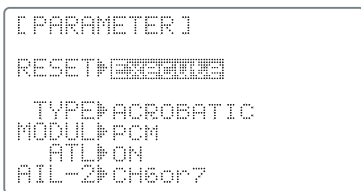

- What is the model's type?
- What type is the receiver's modulation [**PPM** (FM) or **PCM**]?
- Does the model have a normal throttle on channel 3 or do you need full range trim on channel 3 (**ATL**)?
- If you are utilizing either of the twin aileron functions, do you need to tell the radio your receiver is only 5 channels?

First it is important to clear out any old settings in the memory from prior use, using the **MODEL RESET**.

MODEL RESET: completely resets all data in *the individual model you have currently selected*. Don't worry - there is no way you can accidentally delete all models in your radio with this function. Only a service center can completely reset your radio's entire memory at once. To delete each model in your radio's memory (for example when selling), you must **SELECT** each model, reset that memory, then go **SELECT** the next memory, etc.

Note that when you **COPY** one model memory into another or change the model's type, you need not delete all existing data first by using this function. **COPY** completely overwrites anything in the existing model memory, including **MODEL NAME**. The **MODEL TYPE** function overwrites all data except name and **MODUL**.

GOAL of EXAMPLE:	STEPS:	INPUTS:
Reset model memory 1.	Confirm you are currently using the proper model memory. (Ex: 1)	On home screen, check model name and number on top left. If it is not correct, use MODEL SELECT , p. 25.
<i>NOTE: This is one of several functions for which the radio requires confirmation to make a change.</i>	Open PARAMETER submenu.	for 1 second. (If ADVANCE , again.) to 2nd page of menu. to PARAMETER .
	Reset the Memory.	for one second.
	<i>Confirm the change.</i>	sure? displays. *
	Close.	
<i>Where next?</i>	Now that the memory is reset, name has returned to the default (Ex: MODEL-01). NAME the model: p. 25. COPY a different model into this memory: p. 25. SELECT a different model to edit or delete: p. 25. Change the MODEL TYPE to glider or helicopter: see p. 28. Change the receiver modulation from FM (PPM) to PCM or vice versa: see p. 28. Utilize servo REVERSE : see p. 31. Adjust servo travel with END POINT : see p. 32. Set up dual/triple rates and exponential (D/R,EXP): see p. 35.	

*Radio emits a repeating “beep” and shows progress on screen as the model memory is being copied. Note that if the power switch is turned off prior to completion, the data will not be copied.

MODEL TYPE: sets the type of programming used for this model.

The 9C has 8 model memories, which can each support:

- one powered aircraft (**ACRO**) memory type (with multiple wing and tail configurations. See twin aileron servos, twin elevator servos, **ELEVON**, and **V-TAIL** for further information.);
- two glider wing types (again with multiple tail configurations). See Glider **MODEL TYPE** for details, p. 68;
- five helicopter swashplate types, including CCPM. See Helicopter **MODEL TYPE** for details, p. 77.

Before doing anything else to set up your aircraft, first you must decide which **MODEL TYPE** best fits this particular aircraft. (Each model memory may be set to a different model type.) If your transmitter is a 9CA, the default is **ACRO**. If it is a 9CH, the default is **HELI(SW1)**.

ACRO is the best choice for most powered airplanes, but in some circumstances, **GLID2FLP** may be a better choice. **ACRO** is usually a better choice because of functions it offers that the **GLID** types do not:

- **ACRO** adds:
 - **SNAP-ROLL**
 - **AILEVATOR** (twin elevator servo support)
 - **AIRBRAKE** (a more assignable version of **BUTTERFLY**)
 - For fuel-powered airplanes: **IDLE-DOWN**, **THR-CUT**, **THROTTLE-NEEDLE** mixing and **THROTTLE DELAY** programming.
- But **ACRO** lacks:
 - **START** and **SPEED OFFSETS**
 - Built-in programming which defaults outboard ailerons as flaperons and sets up two flap servos to also operate as flaperons for a 4-trailing-edge-surface wing.

*If you are using a glider or heli **MODEL TYPE**, please go to that chapter now to select the proper model type and support your model setup. Note that changing **MODEL TYPE** resets all data for the model memory, including its name.*

GOAL of EXAMPLE:	STEPS:	INPUTS:
Select the proper MODEL TYPE for your model. Ex: ACRO . <i>[NOTE: This is one of several functions that requires confirmation to make a change. Only critical changes (see p xxxx for listing) require additional keystrokes to accept the change.]</i>	Open the BASIC menu, then open the PARAMETER submenu.	Turn on the transmitter. [MODE] for 1 second. (If ADVANCE , [MODE] again.) [CURSOR] then [GLOBE] to highlight PARAMETER . [PRESS] to choose PARAMETER .
	Go to MODEL TYPE .	[CURSOR] to TYPE .
	Select proper MODEL TYPE . Ex: ACRO . Confirm the change. Close PARAMETER .	[GLOBE] to ACROBATIC . [PRESS] for 1 second. sure? displays. [PRESS] to confirm. [END] to return to BASIC menu.

Modulation select (MODUL): sets the type of modulation transmitted.

The modulation of your receiver will determine whether you utilize **PPM** or **PCM** setting in **MODUL** during transmission. Note that you have to turn your transmitter off and back on before a modulation change becomes effective. If you choose **PCM**, be sure you understand and set the FailSafe (**F/S**) settings as you intended (see p. 43). Both modulations transmit on FM waves, use the FM trainer cord, and the FM module.

PCM = Pulse Code Modulation **PPM** = Pulse Position Modulation (also called FM).

Adjustability:

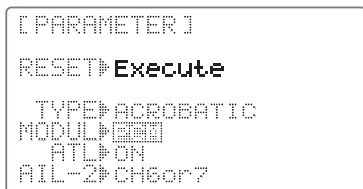

- **PCM** setting for all Futaba PCM1024 receivers, regardless of number of channels (ie. R138DP/148DP/149DP, R309DPS);
- **PPM** setting for all Futaba compatible (negative shift) FM receivers, regardless of number of channels (ie. R127DF, R123F, R148DF).
- *Not compatible with PCM512 receivers* such as the R128DP and R105iP.
- *Not compatible with other brands of PCM receiver, or positive shift FM receivers (ie. JR, Airtronics).*
- You do *not* need a different module in the radio to transmit in **PCM**. For more information on **PCM**, please see our website.

NOTE: When you change models in **MODEL SELECT**, if the new model is set to the other modulation type, you must cycle the transmitter power to change modulations. The modulation will flash on the home screen to remind you until you do so. See p. 25, **MODEL SELECT**, for details.

GOAL of EXAMPLE:	STEPS:	INPUTS:
Change model 1 from FM (PPM) to PCM .	Confirm you are currently using the proper model memory (Ex: 1)	On home screen, check model name and number on top left and the modulation on top right. If it is not the correct model, use MODEL SELECT , p. 25.
	Open BASIC menu, then open PARAMETER submenu.	[MODE] for 1 second. (If ADVANCE , [MODE] again.) [CURSOR] to 2nd page of menu. [GLOBE] to PARAMETER . [PRESS]
	Go to MODUL and change setting.	[CURSOR] [CURSOR] to MODUL . [GLOBE] to PCM . <i>cycle power flashes on screen</i>
	Close menu and cycle power.	[END] [END] POWER OFF. POWER ON.
<i>Where next?</i>	Now that the model is in the proper modulation, the 9C should communicate with the receiver. If it does not, confirm the modulation/frequency of the receiver. [Futaba receivers ending in F use PPM (ex: R127DF), ending in P use PCM (ex: R149DP)]. Change MODEL TYPE to glider/helicopter: see p. 28. Set F/S settings for when PCM receiver sees interference: see p. 43. Utilize servo REVERSE : see p. 31. Adjust servo travel with END POINT : see p. 32. Set up dual/triple rates and exponential (D/R,EXP): see p. 35.	

Second aileron (AIL-2) (ACRO/ GLID1FLP only): changes the default choice for dual aileron servos from channels 6 (**FLAPERON**) or 7 (**AIL-DIF**) to channels **5 and 6**. This allows you to utilize these 2 great functions while utilizing a 5-channel receiver. **NOTE:** Changing **AIL-2 only** tells the system which servos to utilize if **FLAPERON** or **AIL-DIF** is activated. You still must activate that function and complete its setup. For details on twin aileron servos, including using **AIL-2**, see p. 47.

Adjustable travel limit (ATL): makes the channel 3 *TRIM LEVER (THROTTLE TRIM)* effective only at low throttle, disabling the trim at high throttle. This prevents pushrod jamming due to idling trim changes. This function defaults to **ON**. If you are not using channel 3 for throttle, you may want trim operation the same as on all other channels. To do so, set **ATL** to **OFF**.

If you need the **ATL** to be effective at the top of the stick instead of the bottom, reverse the **THR-REV** setting. Note that this affects all models in the radio, not just the model you are currently editing. See servo **REVERSE**, p. 31.

GOAL of EXAMPLE:	STEPS:	INPUTS:
Change ATL from ON to OFF for battling robot, tank, airbrake and other channel 3 uses.	Open BASIC menu, then open PARAMETER submenu.	for 1 second. (If ADVANCE , again.) to 2nd page of menu. to PARAMETER .
	Go to ATL and Change. (Ex: to OFF)	to OFF .
	Close.	
<i>Where next?</i>	Set up ELEVON for tank-style control, throttle/steering on one <i>STICK</i> : see p. 48. Set up IDLE-DOWN and THR-CUT to adjust channel 3 servo at low-stick: see p. 33. Reassign auxiliary channels 5-9 (ex: from dial to switch/slider): see p. 39. Utilize servo REVERSE : see p. 31. Adjust servo travel with END POINT : see p. 32. Set up dual/triple rates and exponential (D/R,EXP): see p. 35.	

Servo reversing (REVERSE): changes the direction an *individual* servo responds to a *CONTROL STICK* motion. [Since channel 9 is switch only (and only available with a **PCM** receiver), its servo **REVERSE** is in the **AUX-CH** control screen with its switch assignment. See p. 39.] For CCPM helicopters, be sure to read the section on **SWASH AFR** (p. 79) before reversing any servos.

```
[REVERSE]  →1:AIL  NOR
             2:ELE  NOR
             3:ARB  NOR
CH1: AILE  4:RUD  NOR
REV  [ ]  5:FLA  NOR
             6:FLA  NOR
             7:AUX  NOR
             8:AUX  NOR
```

Except with CCPM helicopters, always complete your servo reversing *prior* to any other programming. If you use pre-built **ACRO/GLID** functions that control multiple servos, such as **FLAPERON** or **V-TAIL**, it may be confusing to tell whether the *servo* needs to be reversed or a setting in the *function* needs to be reversed. See the instructions for each specialized function for further details.

⚠ Always check servo direction prior to *every* flight as an additional precaution to confirm proper model memory, hook ups, and radio function.

NOTE: **THR-REV** is a special function that reverses the entire throttle control, including moving the trim functionality to the *Stick's* upper half. To use **THR-REV**, turn off the transmitter, hold down the **MODE** and **END** keys, turn on. **CURSOR DOWN** to **THR-REV** and turn the **DIAL** to **REV**. Turn the transmitter off and back on. This change affects all models in the radio.

GOAL of EXAMPLE:	STEPS:	INPUTS:
Reverse the direction of the elevator servo.	Open REVERSE function.	for 1 second. (If ADVANCE , again.) to REVERSE .
	Choose proper channel and set direction. (Ex: ELE REV)	to ELE . to REV .
	Close.	
<i>Where next?</i>	Adjust servo travel with END POINT : see p. 32. Set up dual/triple rates and exponential (D/R,EXP): see p. 35. Set up flight timers: see p. 38. Set up trainer functions: see p. 40.	

End Point of servo travel adjustment (END POINT, also called EPA): the most flexible version of travel adjustment available. It independently adjusts each end of each individual servo's travel, rather than one setting for the servo that affects both directions. Again, for CCPM helicopters, be sure to see **SWASH AFR** (see p. 79) prior to adjusting end points.

Adjustability:

```
[E.P.OINT]→1:AIL100/100
                2:ELE100/100
                3:THR100/100
CH1: AILE      4:RUD100/100
  + →         5:GER100/100
  [ ] 100%    6:FLA100/100
                7:AUX100/100
                8:AUX100/100
```

- Can set each direction independently.
- Ranges from 0% (no servo movement at all) to 140%. At a 100% setting, the throw of the servo is approximately 40° for channels 1-4 and approximately 55° for channels 5-8.
- Reducing the percentage settings reduces the total servo throw in that direction.

Examples:

- Adjust the throttle high end to avoid binding at the carburetor, and low end to allow for proper carburetor closure.
- Adjust flap so up travel is only sufficient for straight and level flight trimming, with full down travel.
- **END POINT** may be adjusted to **0** to keep a servo from moving one direction, such as flaps not intended to also operate as spoilers.
- Retract servos are **not** proportional. Changing **END POINT** will not adjust the servo.

END POINT adjusts only the individual servo. It will have *no* effect on any other servo that is operated in conjunction with this servo via mix or preset programming such as **FLAPERON**, **AILEVATOR**, etc. This is so that each individual servo can be carefully fine-tuned to avoid binding and other conflicts. To adjust the total travel of a *function* such as **FLAPERON**, make the adjustments in that function's controls. For CCPM helicopters, adjust the total travel of the *function*, such as collective pitch, in **SWASH AFR**.

Adjust the linkage or the END POINT? It is nearly always best to adjust your linkages to get as close as possible prior to utilizing **END POINT**. The higher the **END POINT** setting, the better position accuracy *and* the more servo power available at nearly any position (except if using digital servos). Higher **END POINT** values also mean longer travel time to reach the desired position, as you are utilizing more of the servo's total travel. (For example, using 50% **END POINT** would give you only half the steps of servo travel, meaning every click of trim has twice the effect and the servo gets there in half the time).

- end point (and moving the linkage) = torque, accuracy, but transit time to get there.
- end point (instead of adjusting linkages) = travel time, but torque, accuracy.

GOAL of EXAMPLE:	STEPS:	INPUTS:
Decrease the flap servo throw in the upward direction to 5% to allow trimming of level flight only and down travel to 85% to prevent binding.	Open END POINT function.	for 1 second. (If ADVANCE , again.) to END POINT .
	Choose proper channel and set direction. (Ex: flap up 5%)	to flap. flap control [default is $VR(A)$]. to 5%* $VR(A)$. to 85% .
	Close.	
<i>Where next?</i>	Go to SERVO display to confirm desired end result: see p. 42. Move auxiliary channels 5-9 to different dial(s)/switch(es)/slider(s): see p. 39. Set up IDLE-DOWN and THR-CUT to slow/cut the engine: see p. 33. Set up dual/triple rates and exponential (D/R,EXP): see p. 35. Set up flight timers: see p. 38. Set up trainer functions: see p. 40. Set up twin aileron servos: see p. 44. Set up twin elevator servos: see p. 49.	

*You can reset to the initial values by pressing the **DIAL** for one second.

Engine idle management: IDLE-DOWN and **THR-CUT**: functions which work with the digital *THROTTLE TRIM* to provide a simple, consistent means of engine operation. No more fussing with getting trim in just the right spot for landings or take offs! For additional engine adjustments, see **THROTTLE-NEEDLE** (p. 56) and **THROTTLE DELAY** (p. 57).

⚠ If your throttle cut and idle down are working at the wrong end of your travel — full throttle not idle — then your **THR REV** feature has been reversed. Please see page 31 for instructions.

IDLE-DOWN (ACRO only): lowers the engine idle for: sitting on the runway prior to take off, stalls and spins, and landings. The normal idle setting is a little higher for easier starts and safe flights with less risk of dead sticks.

```
[ IDLE-DOWN ]
MIX▶[ ]
RATE▶ 0x
SW▶C
POSI▶Cntr&Dn
```

Important note: The **IDLE-DOWN** function is not normally used when starting the engine, and its accidental operation may keep your engine from starting. The 9C warns that **IDLE-DOWN** is on when the transmitter is turned on. Be sure to turn off the function, or override the warning by pressing both 2 **SELECT/CURSOR** keys in unison and holding for 1 second if you intended the function to be on.

⚠ This may be assigned to any switch/position. Some modelers accidentally assign **IDLE-DOWN** to one side of a switch and **THR-CUT** to the other. There is no “normal” setting to start the engine. By default **IDLE-DOWN** is set to **SWITCH C** center and down. This works well with **THR-CUT** also on **SWITCH C** down. The **SWITCH up** is normal flight/starting, *center* for slower maneuvers/landing, and *down* to cut the engine. If you assign **IDLE-DOWN** or **THR-CUT** to the spring-loaded **TRAINER SWITCH F** (9CA) or **H** (9CH), then use the trainer function, you may risk loss of throttle control or deadstick for your student.

GOAL of EXAMPLE:	STEPS:	INPUTS:
Decrease the throttle setting at idle with the flip of a switch for spins and landings.	Open BASIC menu, then open IDLE-DOWN function.	for 1 second. (If ADVANCE , again.) to IDLE-DOWN .
	Activate the function.	
	With THROTTLE STICK at idle, adjust the rate until engine idles as desired.*	THROTTLE STICK . until engine idles as desired.
	<i>Optional: change switch assignment. Choose desired switch and position.</i>	to SW . to desired SWITCH . to POSI . to desired position.
	Close.	
<i>Where next?</i>	THR-CUT : see p. 34.	

*Normally a value of 10- 20%. Secure the fuselage, engine running. Set the **THROTTLE STICK** to idle. Adjust the **IDLE-DOWN** rate while flipping the switch ON and OFF until the desired idle is achieved. Be sure to throttle up periodically to allow the engine to “clean out” and idle reliably.

Throttle cut (THR-CUT) (ACRO/HELI): provides an easy way to stop the engine by flipping a switch (with *THROTTLE STICK* at idle). The movement is largest at idle and disappears at high throttle to avoid accidental dead sticks. In **HELI**, there is an additional setting, **THR**. See p. 82.

```
[THR-CUT]
MIX>[ ]
RATE> 0%
SW>A
POS>NULL
```

The switch's location and direction *must* be chosen. It defaults to **OFF** to avoid accidentally assigning it to a switch, which might result in an unintentional dead stick in flight. Please see ⚠ for **IDLE-DOWN** and **THR-CUT** on p. 33.

GOAL of EXAMPLE:	STEPS:	INPUTS:
Decrease the throttle setting (at idle) to stop the engine with the flip of a switch. <i>(Note that you MUST assign a switch. The default is NULL. We recommend SWITCH C in the down position, with IDLE-DOWN programmed to SWITCH C in the center and down positions.)</i>	Open BASIC menu, then open THR-CUT function.	for 1 second. (If ADVANCE , again.) to THR-CUT .
	Activate the function. Choose desired switch, and the position which activates the function.	to MIX . to SW . to C . to POS . to DOWN .
	With <i>THROTTLE STICK</i> at idle, adjust the rate until the engine consistently shuts off but throttle linkage is not binding.*	to down position. <i>THROTTLE STICK</i> . to RATE . until shuts off.
	Close.	
<i>Where next?</i>	Set up dual/triple rates and exponential (D/R,EXP): see p. 35. Set up TRAINER functions: see p. 40. Set up twin aileron servos: see p. 44. Set up twin elevator servos: see p. 49.	

*Normally, a setting of 10-20% is sufficient. Viewing the carburetor barrel until it fully closes is adequate to get an approximate setting; then test with engine running to confirm.

Dual/triple rates and exponential (D/R,EXP): assigns adjusted rates and exponential.

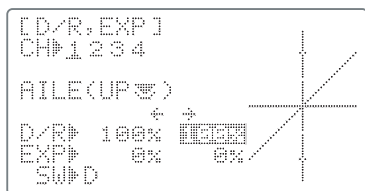

Dual/Triple Rates: reduce/increase the servo travel by flipping a switch, or (**ACRO/GLIDER**) they can be engaged by any stick position. Dual rates affect the control listed, such as aileron, not just a single (ex: channel 1) servo. For example, adjusting aileron dual rate will affect both aileron servos when using **FLAPERON** or **AIL-DIF**, and both aileron and elevator servos' travel when using **AILEVATOR** or **ELEVON** or a CCPM helicopter.

Activation:

- Any **SWITCH, A-H**. If you choose a 3-position switch, then that dual rate instantly becomes a **triple rate** (see example).
- Stick position (**ACRO/GLIDER**). (*Ex:* On rudder you normally use only the center 3/4 of the stick movement except for extreme maneuvers such as snaps/spins/stalls. As long as your **RUDDER STICK** does not exceed 90% of maximum throw, the rudder responds at your lower rate, allowing small, gentle corrections. When the stick passes 90% (ie. stall turn), the rudder goes to high rate's 90%, which is a MUCH higher amount of travel than your low rate at 89%.)

Ex: EPA = 1" Low Rate = 50% High Rate = 100%
 At 89% Low Rate = .45" High Rate = .9"
 At 90% High Rate = .9"

Adjustability:

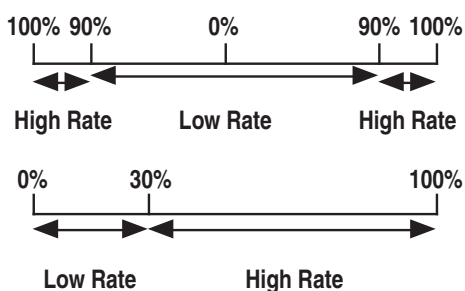

- Range: 0 - 140% (0 setting would deactivate the control completely.)
Initial value=100%
- Adjustable for each direction(**ACRO/GLIDER**). (ie. Up/down, left/right) (*Ex:* Most models fly upright without any elevator trim, but require some down elevator when inverted just to maintain level flight. By increasing the down travel by the amount required to hold the model inverted, the model now has equal travel available from level upright or level inverted.)

Exponential: changes the response curve of the servos relative to the stick position to make flying more pleasant. You can make the servo movement less or more sensitive around neutral for rudder, aileron, elevator, and throttle (except **HELI** type - use **THROTTLE CURVE** instead).

Why use expo? Many models require a large amount of travel to perform their best tricks. However, without exponential, they are "touchy" around neutral, making them unpleasant to fly and making small corrections very difficult. Additionally, by setting different exponentials for each rate, you can make the effectiveness of small corrections similar in each rate, as in our example below.

The best way to understand exponential is to try it:

- Having made no changes yet in the **D/R,EXP** screen, move **SWITCH D** to "down" (toward the **AILERON STICK**).
- Cursor down to **EXP** and dial to **100%**.
- Move **SWITCH D** up. Hold the **AILERON STICK** at 1/4 stick and move **SWITCH D** down.
- Notice how much less travel there is.
- Go to 3/4 stick and repeat. Notice how the travel is much closer, if not identical.

Adjustability:

- More sensitive around neutral. (positive exponential, see example)
- Less sensitive around neutral. (negative exponential, see example)
- Adjustable for each direction. (**ACRO/GLIDER**)

For throttle, exponential is applied at the low end to help nitro and gasoline engines have a linear throttle response, so that each 1/4 stick increases engine RPM 25% of the available range. (In most engines this ranges from 5-60%.)

Special note for helicopters: Helicopter model types have just a single rate for each switch position rather than a rate for each side of the servo's travel per switch position. Additionally, setting the **D/R,EXP** for each switch position requires cursoring back to the **No.** setting and changing the switch position here. Just flipping the switch does not affect the screen setting, allowing dual rates to be assigned with idle-up and other features on certain switches, and does not require putting the model in that condition to make modifications.

GOAL of EXAMPLE:	STEPS:	INPUTS:
Set up dual rates and exponential in a HELI model.	Open D/R,EXP .	for 1 second. (If ADVANCE , again.) to D/R,EXP .
	Choose channel.	to desired channel.
	Choose first switch position.	to UP .
	Set rate and exponential (Ex: high rate = 95%, 0% exponential.)	to 95%. Confirm 0% EXP .
	Go to 2 nd switch position and set rate and exponential.	to DN . Repeat above.
	<i>Optional: if using a 3 position switch, set 3rd rate.</i>	to CT . Repeat above.
	<i>Optional: assign dual rates to have one for each condition.</i>	to COND . Repeat steps above to adjust for each condition.

GOAL of EXAMPLE:	STEPS:	INPUTS:
<p>Set up aileron triple rates on SWITCH C with travel settings of 75% (normal), 25% (slow roll) and 140% (extreme aerobatics) and exponential settings of 0%, +15%, and -40% respectively.</p> <p>NOTE: This normal rate has no exponential so it has a very linear, normal feel. This slow roll rate has <i>positive</i> exponential (the opposite of what most people normally use), which makes the servos more responsive around center. This makes the servos feel the same around center in the normal and low rates, but still gives a very slow roll rate at full stick.</p> <p>The 3D rate (extreme aerobatics) has a very high distance of travel B nearly twice that of the normal rate. Therefore, using a very high <i>negative</i> exponential setting softens how the servos respond around center stick. This makes the servos respond similarly around center stick for a more comfortable feel.</p> <p>Many modelers like to set up all 3 triple rates on a single 3-position switch, creating a “slow and pretty mode”, a “normal mode”, and a “wild stunts mode” all with the flip of a single switch. To do so, simply set up rates for all 3 controls and assign all 3 to the same 3-position switch.</p>	<p>Open D/R,EXP function.</p>	<p> for 1 second. (If ADVANCE, again.)</p> <p> to D/R,EXP. </p>
	<p>Choose the channel to change (Ex: aileron is already selected)</p>	<p> to desired channel. </p>
	<p><i>Optional: change switch assignment.</i></p>	<p> to C. </p>
	<p>Confirm switch is in desired position and set rate. (Ex: up = high rate, 75%).</p>	<p> C to up position.</p> <p> AILERON STICK. to 75%.</p> <p> AILERON STICK. to 75%.</p>
	<p>Move SWITCH to 2nd rate position and set this particular rate. (Ex: center = low rate, 25%).</p>	<p> C to center position.</p> <p> AILERON STICK. to 25%.</p> <p> AILERON STICK. to 25%.</p>
	<p><i>Optional: if using a 3 position SWITCH, move SWITCH to 3rd position and set this rate (Ex: down = 3D rate, 140%).</i></p>	<p> C to down position.</p> <p> AILERON STICK. to 140%.</p> <p> AILERON STICK. to 140%.</p>
	<p><i>Optional: instead of using a switch, you can set high rates to be triggered when the stick moves past a certain point. To test this, set aileron high rate to 25%. Now set switch assignment to AIL (90%). Move AILERON STICK to the right and notice the huge jump in travel after the stick moves 90% of its distance.</i></p>	<p> C to up position.</p> <p> AILERON STICK. to 25%.</p> <p> AILERON STICK. to 25%.</p> <p> to SW. to ail (90%).</p> <p> </p> <p> AILERON STICK and watch screen graph. See the change?! <i>You may also change the trigger point by holding the stick at the desired point, then pressing and holding the DIAL.</i></p>
	<p>Set each rate's EXP. (Ex: 0%, +15%, -40%)</p>	<p> C to up position.</p> <p> confirm EXP reads 0.</p> <p> C to down position.</p> <p> AILERON STICK. to +15%.</p> <p> AILERON STICK. to + 15%.</p> <p> C to center position.</p> <p>repeat to set low rate expo to -40%. </p>
<p><i>Repeat above steps for elevator and rudder.</i></p>	<p> </p>	
<p>Close.</p>	<p> </p>	
<p><i>Where next?</i></p>	<p>Set up flight timers: see p. 38. Set up TRAINER functions: see p. 40. Adjust the sensitivity of the trims: see p. 41. Set up twin aileron servos: see p. 44. Set up twin elevator servos: see p. 49. Set up programmable mixes to meet your specific needs: see p. 53. www.futaba-rc.com/faq/faq-9c.html for all triple rates on a single switch, etc.</p>	

TIMER submenu (stopwatch functions): controls two electronic clocks used to keep track of time remaining in a competition time allowed, flying time on a tank of fuel, amount of time on a battery, etc.

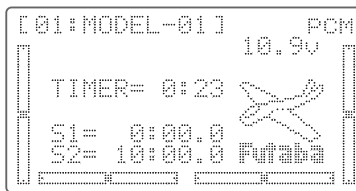
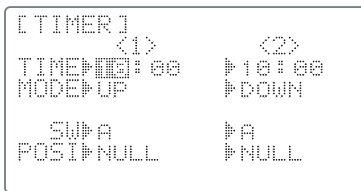

Adjustability:

- Count down timer: starts from the chosen time, displays time remaining. If the time is exceeded, it continues to count below 0.
- Count up timer: starts at 0 and displays the elapsed time up to 99 minutes 59 seconds.
- Independent to each model, and automatically updates with model change.
- In either **TIMER** mode, the timer beeps once each minute. During the last twenty seconds, there's a beep each two seconds. During the last ten seconds, there's a beep each second. A long tone is emitted when the time selected is reached.
- To Reset, choose the desired timer with the **SELECT** key (while at the startup screen), then press and hold **DIAL** for 1 second.
- Activation by either direction of **SWITCH A-H**, by **THROTTLE STICK (STK-THR)** (Using the **THROTTLE STICK** is convenient if you are keeping track of fuel remaining, or for an electric, how much battery is left); or by the power **SWITCH (PWRSW)**.

GOAL of EXAMPLE:	STEPS:	INPUTS:
Set timer 2 to count down 4-1/2 minutes, being controlled by THROTTLE STICK position. This is utilized to keep track of actual Throttle on time to better correlate with fuel/battery usage.	Open BASIC menu, then open TIMER function.	MODE for 1 second. (If ADVANCE , MODE again.) to page 2. to TIMER .
	Go to TIMER<2> .	
	Adjust time to 4 min. 30 sec., count down.	to 4. to 30.
	Assign to THROTTLE STICK and set trigger point (if timer is to trigger BELOW this throttle point, so arrow points down).	to SW . 2 steps to STK THR . to POSI . THROTTLE STICK to desired position (Ex: 1/4 stick). for 1 second to set.
	Close.	END END
<i>Where next?</i>	Adjust END POINTS after first flight test: see p. 32. Adjust auxiliary channel assignments (ex: move flaps to a switch): see p. 39. Set up TRAINER functions: see p. 40.	

Auxiliary channel function (including channel 9 controls) (AUX-CH): defines the relationship between the transmitter controls and the receiver output for channels 5-9. Also, the **CH9 SERVO REVERSE** is used to change the CH9 servo direction. Note that the CH9 functions are only visible in the **AUX-CH** screen when **PCM** modulation is selected. The 9th channel is not supported in **FM** modulation.

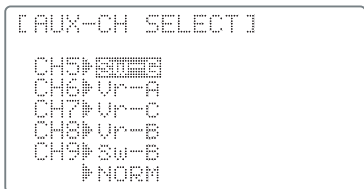

Adjustability:

- channels 5-9 may be assigned to any **SWITCH (A-H)**, slider [**VR(D)** and **VR(E)**], or knob [**VR(A-C)**] (for example, moving flaps to a switch or slider), but not the primary control sticks (use programmable mixes to do so, p. 59);
- multiple channels may be assigned to the same switch, slider or knob;
- channels set to “**NULL**” are only controlled by mixes. (Ex: utilizing 2 channels for 2 rudder servos. See mixes, p. 59.)

⚠ Remember that if you assign primary control of a channel to a switch which you later use for other functions (like dual/triple rates or airbrakes), every time you use that other function you will also be moving the auxiliary channel.

GOAL of EXAMPLE:	STEPS:	INPUTS:
Assign flaps to the right slider [VR(E)] and set channel 7 to NULL in preparation to use it as a smoke system control (the smoke system being activated later by a throttle-to-ch.-7 mix).	Open BASIC menu, then open AUX-CH function.	for 1 second. (If ADVANCE , again.) to page 2.
	Choose the channel to change. (ex: ch. 6.)	
	Change primary control. (ex: to slider.)	to Vr-E .
	Repeat as needed. (ex: ch. 7 to NULL .)	to Ch 7 . to NULL .
	Close.	
<i>Where next?</i>	Programmable mixes: see p. 53. Set up dual/triple rates and exponential (D/R,EXP): see p. 35. Adjust SUB-TRIM of auxiliary channel to adjust center SWITCH position: see p. 41. Adjust END POINTs (sets end points of travel even when using a switch): see p. 32.	

TRAINER: for training novice pilots with optional trainer cord connecting 2 transmitters. The instructor has several levels of controllability.

```
[ TRAINER ] 1: AIL FUNC
             2: ELE FUNC
             3: THR FUNC
             4: RUD FUNC
CH1: AILE   5: GER OFF
             6: FLA OFF
             7: AUX OFF
             8: AUX OFF
```

Adjustability:















- **NORM:** When the **TRAINER SWITCH** is ON, the channel set to this mode can be controlled by the student. The set channel is controlled according to any programming set at the *student's* transmitter.
- **FUNC:** When the **TRAINER SWITCH** is ON, the channel set to this mode can be controlled by the student, controlled according to *any mixing* set at the *instructor's* transmitter.
- **OFF:** The channel set to this mode cannot be controlled by the student even when the **TRAINER SWITCH** is ON. The set channel is controlled by the instructor only, even when the **TRAINER SWITCH** is ON.
- **SWITCH:** controlled by spring-loaded **SWITCH F** (9CA) or **H** (9CH) only. Not assignable.
- **Compatibility:** The 9C may be master or student with any Futaba FM transmitter compatible with the cord. Simply plug the optional trainer cord (For 9C series, sold separately) into the trainer connection on each transmitter, and follow the guidelines below.

Examples:

- When throttle/collective are set to **FUNC**, 5-channel helicopter practice is possible with a 4-channel transmitter.
- Set up the model in a second transmitter, use **NORM** mode to quickly and safely check proper operation of all functions, then allow the student radio to fully fly the model.
- Using **NORM** mode, set lower throws, different exponentials, even different auxiliary channel settings on the student radio (if it has these features).
- To ease the learning curve, elevator and aileron may be set to the **NORM** or **FUNC** mode, with the other channels set to **OFF** and controlled by the instructor.

 *Precautions:*

- NEVER turn on the student transmitter power.
- ALWAYS set the student transmitter modulation mode to **PPM**.
- BE SURE that the student and instructor transmitters have identical trim settings and control motions. Verify by switching back and forth while moving the control sticks.
- FULLY extend the instructor's antenna. Collapse the student's antenna.
- Always remove the student transmitter's RF module (if it is a module-type transmitter).
- When the **TRAINER** function is active, the snap roll function is deactivated. Other functions, such as **IDLE-DOWN** and **THR-CUT**, which have been assigned to the same switch, are *not* deactivated. Always double check your function assignments prior to utilizing the **TRAINER** function.
- When you select a different model, the **TRAINER** function is deactivated in the current model for safety reasons.

GOAL of EXAMPLE:	STEPS:	INPUTS:
Turn on the TRAINER system and set up so student has: fully functional control of aileron and elevator to support FLAPERON and AILEVATOR ; normal control of rudder to allow lowered travel; and no throttle channel control (with the instructor for safety).	Open BASIC menu, then open TRAINER function.	 for 1 second. (If ADVANCE ,  again.)  to page 2.  to TRAINER . 
	Activate TRAINER .	 to OFF .
	Choose desired channel(s) and proper training type(s).	 past AIL and ELE (default OK).  to THR ,  to OFF .  to RUD ,  to NORM .
	Close.	 
	TEST student radio function fully prior to attempting to fly!	
<i>Where next?</i>	Set student 9C to PPM (required regardless of receiver's modulation): see p. 28. Set up dual/triple rates and exponential (D/R,EXP) on student 9C: see p. 35. Reset trims on student 9C: see p. 41.	

TRIM submenu: resets and adjust effectiveness of digital trims.

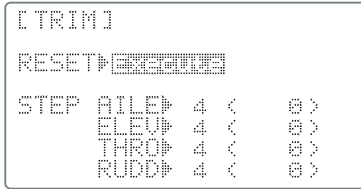

The 9CA has digital trims which are different from conventional mechanical trim sliders. Each **TRIM LEVER** is actually a two-direction switch. Each time the **TRIM LEVER** is pressed, the trim is changed a selected amount. When you hold the **TRIM LEVER**, the trim speed increases. The current trim position is graphically displayed on the start up screen. The **TRIM** submenu includes two functions that are used to manage the trim options.

HELI models only: **OFFSET** is available in the idle ups. If **OFFSET** is inhibited, adjustment of the **TRIM LEVERS** will adjust the trims for all flight conditions. If **OFFSET** is active, then moving the trims within any one condition will effect only that condition. See **OFFSET**, p. 86.

Trim reset (RESET): electronically centers the trims to their default values. Note that the **SUB-TRIM** settings and the trim **STEP** rate are not reset by this command.

GOAL of EXAMPLE:	STEPS:	INPUTS:
Reset trims to neutral after having adjusted all linkages.	Open BASIC menu, then open TRIM submenu.	for 1 second. (If ADVANCE , again.) to TRIM .
<i>NOTE: This is one of several functions for which the radio requires confirmation to make a change.</i>	Request <i>and confirm the reset.</i>	for 1 second. Beep sounds.
	Close.	
<i>Where next?</i>	Adjust SUB-TRIMs : see p. 42. Adjust trim rate (STEP): see below. Adjust END POINTs : see p. 32. Set up dual/triple rates and exponential (D/R,EXP): see p. 35.	

Trim step (STEP): changes the rate at which the trim moves when the **TRIM LEVER** is activated. It may be set from 1 to 40 units, depending on the characteristics of the aircraft. Most ordinary aircraft do well at about 2 to 10 units. Generally larger trim steps are for models with large control throws or for first flights to ensure sufficient trim to properly correct the model. Smaller trim steps are later used to allow very fine adjustments in flight.

GOAL of EXAMPLE:	STEPS:	INPUTS:
Double the sensitivity (larger step) of the AILERON TRIM LEVERS for a first flight of an aerobatic model to ensure sufficient range to trim the model for level flight.	Open TRIM submenu and choose the STEP you wish to change. (Ex: aileron)	for 1 second. (If ADVANCE , again.) to TRIM .
	Adjust the size of the step. (Ex: incr. to 8)	to 8.
	Repeat as desired for other channels.	to ELEV . to new setting. Repeat as needed.
	Close.	
<i>Where next?</i>	Adjust sub trims: see p. 42. Adjust END POINTs : see p. 32. Set up dual/triple rates and exponential (D/R,EXP): see p. 35.	

SUB-TRIM: makes small changes or corrections to the neutral position of each servo. Range is -120 to +120, with 0 setting, the default, being no **SUB-TRIM**.

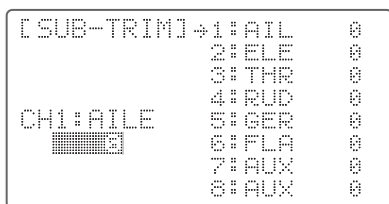

We recommend that you center the digital trims before making **SUB-TRIM** changes, and that you try to keep all of the **SUB-TRIM** values as small as possible. Otherwise, when the **SUB-TRIMs** are large values, the servo's range of travel is restricted on one side.

The recommended procedure is as follows:

- measure and record the desired surface position;
- zero out both the trims (**TRIM RESET** menu) and the **SUB-TRIMs** (this menu);
- mount servo arms and linkages so that the control surface's neutral is as correct as possible; and
- use a small amount of **SUB-TRIM** to make fine corrections.

GOAL of EXAMPLE:	STEPS:	INPUTS:
Adjust the flap servo's SUB-TRIM until its center exactly matches the aileron servo's center, as they are to work together as flaperons.	Open BASIC menu, then open SUB-TRIM .	MODE for 1 second. (If ADVANCE , MODE again.) ↓ CURSOR to SUB-TRIM .
	Choose the channel to adjust, and adjust until surfaces match. (Ex: flap)	↓ ↓ ↓ ↓ ↓ CURSOR CURSOR CURSOR CURSOR CURSOR as needed. ↓ CURSOR to each channel,
	Repeat for other channels.	as needed.
	Close.	END END
<i>Where next?</i>	Adjust trim steps: see p. 41. Adjust END POINTS : see p. 32. Set up dual/triple rates and exponential (D/R,EXP): see p. 35.	

SERVO display and cycle submenu: displays radio's output to channels 1-8.

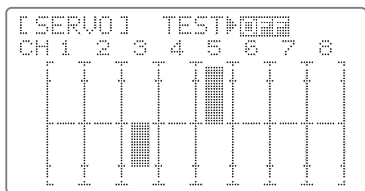

The servo submenu includes two features:

- real-time bar-graph display to demonstrate exactly what commands the transmitter is sending to the servos. (This can be particularly handy in setting up models with complicated mixing functions, because the results of each stick, lever, knob, switch input and delay circuit may be immediately seen.); and
- servo cycle function to help locate servo problems prior to in-flight failures.

GOAL of EXAMPLE:	STEPS:	INPUTS:
View the result of reassigning channel 6 from VR(A) knob to three-position SWITCH C . Cycle the channel 6 servo.	Complete desired programming function. (Ex: in AUX-CH , move ch. 6 to SWITCH C)	See AUX-CH for details. (p. 39.)
	Open the SERVO function.	MODE for 1 second. (If ADVANCE , MODE again.) 1 step to SERVO .
	Move each control to see exactly how operating. (Ex: SWITCH C in all positions)	C to center position. Note change in position of ch. 6 servo.
	Prepare all servos to be cycled and cycle.	Plug in servos. POWER ON .
	End cycling and close.	END END
<i>Where next?</i>	Set up dual/triple rates and exponential (D/R,EXP): see p. 35. Set up desired programmable mixes: see p. 54. Set up dual aileron servos: see p. 44. Set up dual elevator servos: see p. 49.	

FailSafe (loss of clean signal and low receiver battery) submenu (PCM mode only) (F/S): sets responses in case of loss of signal or low Rx battery.

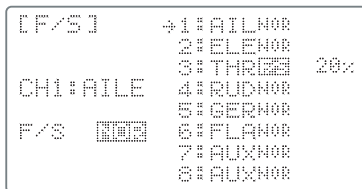

FailSafe (F/S): instructs a PCM receiver what to do in the event radio interference is received.

Adjustability:

- Each channel may be set independently.
- The **NORM** (normal) setting holds the servo in its last commanded position.
- The **F/S** (FailSafe) function moves each servo to a predetermined position.
- NOTE: the setting of the throttle's **F/S** also applies to the Battery **F/S** (see below).

Examples:

- The **F/S** setting is used in certain competitions to spin the aircraft to the ground prior to flying away and doing potential damage elsewhere. Conversely, may also be used to go to neutral on all servos, hopefully keeping the plane flying as long as possible.
- Competition modelers often maintain the **NORM** function so that brief interference will not affect their model's maneuver.
- Set the throttle channel so that the engine idles when there is interference (**ACRO**). This may give enough time to fly away from and recover from the radio interference and minimize damage if crashed.
- For helicopters, **NORM** is typically the safest choice.
- We also recommend setting a gasoline engine's electronic kill switch to the **OFF** position in the **F/S** function for safety reasons.

Updating F/S Settings: If you specify a **F/S** setting, the FailSafe data is automatically transmitted once each two minutes. When you choose the **F/S** mode, check that your settings are as desired by turning off the transmitter power switch and verifying that the servos move to the settings that you chose. Be sure to wait at least two minutes after changing the setting **and** turning on the receiver power before turning off the transmitter to confirm your changes have been transmitted.

GOAL of EXAMPLE:	STEPS:	INPUTS:
Change the receiver FailSafe command for channel 8 (gasoline engine kill switch) to a preset position. <i>NOTE: This is one of several functions for which the radio requires confirmation to make a change.</i>	Open the BASIC menu, then open F/S function.	for 1 second. (If ADVANCE , again.) to F/S .
	Choose Channel to change. (ex: Ch. 8)	to Ch 8.
	Set and confirm fail safe command.	that controls channel 8 to desired OFF position. for 1 second to store.
	Repeat as desired.	
	Close.	
<i>Where next?</i>	<i>Wait two minutes and confirm F/S settings as described above. Read below for information on Battery FailSafe. Adjust END POINTS to gain proper F/S responses if needed: see p. 32. Adjust SUB-TRIM to gain proper F/S responses if needed: see p. 41.</i>	

Battery FailSafe (F/S): a second battery low warning feature (separate from the transmitter low voltage warning). When the *airborne* battery voltage drops below approximately 3.8V, the *PCM receiver's* battery **F/S** function moves the throttle to a predetermined position. When the Battery **F/S** function is activated, your engine will move to idle (if you haven't set a position) or a preset position. You should immediately land. You may temporarily reset the Battery **F/S** function by moving the **THROTTLE STICK** to idle. You will have about 30 seconds of throttle control before the battery function reactivates.

Adjustability:

- **NOR F/S** setting for throttle results in Battery **F/S** going to the servo position reached by moving **THROTTLE STICK** to the bottom with **TRIM LEVER** centered;
- **POS F/S** setting for throttle results in Battery **F/S** also going to the same throttle servo position as the regular **F/S**.

If using a 6V (5-cell) receiver battery, it is very likely that your battery will be rapidly running out of charge before battery FailSafe takes over. It is *not* a good idea to count on battery FailSafe to protect your model at any time, but especially when using a 5-cell battery.

ACRO ADVANCE MENU FUNCTIONS:

Aircraft wing types (ACRO/GLID):

There are 3 basic wing types in aircraft models:

- Simple. Model uses one aileron servo (or multiple servos on a Y-harness into a single receiver channel) and has a tail. This is the default setup and requires no specialized wing programming.
- Twin Aileron Servos. Model uses 2 aileron servos and has a tail. see *Twin Aileron Servos*.
- Tail-less model (flying wing). Model uses 2 wing servos working together to create both roll and pitch control. see **ELEVON**.

Twin Aileron Servos (with a tail) (ACRO/GLID): Many current generation models use two aileron servos, plugged into two separate receiver channels. (If your model is a flying wing without separate elevators, see **ELEVON**, p. 48.)

Benefits:









- Ability to adjust each servo's center and end points for perfectly matched travel.
- Redundancy, for example in case of a servo failure or mid-air collision.
- Ease of assembly and more torque per surface by not requiring torque rods for a single servo to drive 2 surfaces.
- Having more up aileron travel than down travel for straighter rolls – aileron differential. (see glossary for definition.)
- Using the two ailerons not only as ailerons but also as flaps, in which case they are called flaperons.
- Set a negative percentage to reverse the operation of one of the servos.

Options:

- 5-channel receiver? Set up **AIL-2** (see p. 47) *prior* to continuing with **FLAPERON** or **AIL-DIFF**.
- **FLAPERON:**
 - Uses CH6 for the second servo (see **AIL-2** to use CH5.)
 - Allows flap action as well as aileron action from the ailerons.
 - Provides **FLAP-TRIM** function to adjust the neutral point of the flaperons for level flight.
 - Also allows aileron differential in its own programming (instead of activating **AIL-DIFF**).
- **Aileron Differential (AIL-DIFF):**
 - Uses CH7 for the 2nd servo (see **AIL-2** to use CH5.)
 - Leaves CH6 free for flap operation, such as flaperon and flap action together, in **AIRBRAKE**. (see p. 55).
 - Allows for more up aileron travel than down for straighter rolls.

You will need to choose which is the better choice for your model's setup – **FLAPERON** or **AIL-DIFF**. If you need the ailerons to also operate as flaps, you most likely want to use **FLAPERON**. If your model has 2 aileron servos *and* flaps, then **AIL-DIFF** is probably the easiest choice. (*For details on setting up a complex aerobatic plane, such as one with 4 wing servos using full span ailerons and full span flaps, as well as AIRBRAKE/crow and other features, please visit our FAQ at www.futaba-rc.com/faq/faq-9c.html. Many other setup examples are also available at this location.*)

NOTE: Only one of the three wing-type functions (**FLAPERON**, **AIL-DIFF**, and **ELEVON**) can be used at a time. All three functions cannot be activated simultaneously. To activate a different wing type, the first must be deactivated.

GOAL of EXAMPLE:	STEPS:	INPUTS:
De-activate FLAPERON so that AIL-DIFF or ELEVON can be activated.	Open the FLAPERON function.	 for 1 second. (If basic,  again.)
	De-activate the function.	 to FLAPERON . 
	Close function.	 to MIX .  to INH .
		 
<i>Where next?</i>	Set up AIL-DIFF (see p. 47) or ELEVON (see p. 48).	

Using **FLAPERON (ACRO/GLID)**:

```
[FLAPERON]
MIXMODE
      (L)  (R)
RATE-AIL1▶+100% +100%
      AIL2▶+100% +100%

      FLP2▶+100%
      FLP1▶-100%
```

The **FLAPERON** mixing function uses one servo on each of the two ailerons, *and* uses them for both aileron and flap function. For flap effect, the ailerons raise/lower simultaneously. Of course, aileron function (moving in opposite directions) is also performed.

Once **FLAPERON** is activated, any time you program CH6 or “flap” (ie. **FLAP-ELEVATOR** mixing), the radio commands both servos to operate as flaps. The amount of travel available as flaps is independently adjustable in **FLAPERON**. A trimming feature is also available (see **FLAP-TRIM**) to adjust both neutral positions together for straight-and-level flight or slight increases/decreases of the flap angle. **END POINT** and **SUB-TRIM** both still adjust each servo individually.

Adjustability:

- Each aileron servo's up travel can be set separate from its down travel, creating aileron differential. (See example).
- Each aileron servo's travel when actuated as a flap is separately adjustable.
- **AIL2** can be utilized to use a 5-channel receiver and still have flaperons. NOTE: The **AIL2** function only commands the channel 5 servo to operate with the aileron servo as ailerons, and to obey the primary flap control (travel adjusted in **FLAP-TRIM**.) It does not provide full flap mix capability as when using a 6+ channel receiver and channel 6.

NOTE: Activating flaperons only makes the ailerons work as ailerons and tells the radio how far you want them to move as flaps IF you then activate other programming that moves them as flaps.

FLAP-TRIM is the flap-trimming feature that allows the flaps to move in reaction to the channel 6 control. It is meant only for trimming the flaps' center but can also be used as full flap control. (See p. 46).

AIRBRAKE is a feature that drops flaperons as flaps, and also compensates with elevator if desired. (See p. 55).

FLAP-ELEVATOR would add elevator mixing into the flap movement from the flap dial after **FLAP-TRIM** is activated.

GOAL of EXAMPLE:	STEPS:	INPUTS:
Activate twin aileron servos, FLAPERON .	Open the FLAPERON function.	for 1 second. (If basic, again.) to FLAPERON . *
Input 10% less down travel than up travel (aileron differential) within the FLAPERON programming. (Decrease right aileron's down travel to 90% , decrease left aileron's down travel to 90% .)	Activate the function.	
	Optional: adjust the up/down travel separately for the 2 servos. (Ex: 90% down.)	to 90% . to 90% .
	Optional: adjust the aileron's travel so they move as flaps. (Ex: each servo flap travel to 50% .)	to 50% . to -50% .
	Adjust total flap travel available to 50% of aileron travel available.	Close menu.
Where next?	Set FLAP-TRIM : see p. 46. Set up AIRBRAKE mix: see p. 55. Mix flaperon's flap motion to another inboard flap (plugged into aux1): see p. 54. View additional model setups on the internet: www.futaba-rc.com/faq/faq-9c.html	

* If you receive an error message that **OTHER WING MIXING IS ON**, you must deactivate **AIL-DIFF** or **ELEVON**. see p. 44.

Using **FLAP-TRIM** (camber) to adjust flaperons: (**ACRO/GLID**)

```

[FLAP-TRIM]
MIX INH
RATE▶■■■■■END
    
```

FLAP-TRIM assigns the primary flaperon control [defaults to **VR(A)**] to allow trimming in flight of the flap action of flaperons. (Note: even if **FLAP-TRIM** is made active with **AIL-DIFF**, it will not have any effect. The **ONLY** function that allows control of the ailerons as flaps in the **AIL-DIFF** configuration is **AIRBRAKE**.) Most modelers use **AIRBRAKE**, or programmable mixes, to move the flaps to a specified position via movement of a switch.

FLAP-TRIM may also be used as the primary flap control in flight. By doing so, you can assign CH6 to a 3-position switch, with a "spoileron", neutral, and "flaperon" position, and even adjust the percentage traveled as flaperon/spoileron by changing the Flap Trim travel. (Note that there is only one setting, not independent settings for up and down travel.)

Add FLAP-TRIM to allow the model's ailerons to be trimmed together as flaps at any time during the flight, with a maximum travel of 5% of the total flap travel set in FLAPERON .	Open the FLAP-TRIM function.	[MODE] for 1 second. (if basic, [MODE] again.) [Globe] to FLAP-TRIM . [PRESS]
	The function is automatically activated with FLAPERON ; however, the default travel is 0 .	
	Adjust the travel available to the flaperons when turning the CH6 DIAL . (Ex: 5%).	[Globe] to 5% .
	Optional: Use as total flap control. Reassign CH6's primary control in AUX-CH to your desired flap control. (Ex: right slider)	[Globe] to 50% . [END] [MODE] [Globe] to AUX-CH . [PRESS] [CURSOR] to CH6 . [Globe] to Vr-E .
	Close menu.	[END] [END]
Where next?	Adjust individual servo's SUB-TRIMs : see p. 41 and END POINTs : see p. 32. Set up AIRBRAKE mix: see p. 55 and ELEV-FLAP mix: see p. 54. Mix flaperon's flap movement to an additional inboard flap (plugged into aux1): see p. 54. View additional model setups on the internet: www.futaba-rc.com/faq/faq-9c.html .	

Using Aileron Differential (**AIL-DIFF**) (**ACRO/GLID**):

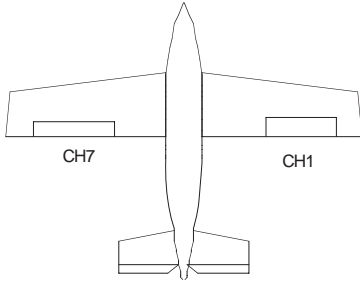

```
[AIL-DIFF]
MIX:0000 (L) (R)
RATE-AIL1+100% +100%
AIL2+100% +100%
```

Aileron differential is primarily used on 3-servo wings, with one servo operating inboard flap(s) on CH6, and **AIL-DIFF** controlling proper aileron operation of 2 aileron servos, plugged into CH1 and CH7. *The ailerons can not be moved like flaps when using **AIL-DIFF**, except if using **AIRBRAKE** (see p. 55.) (Note that even if you make **FLAP-TRIM** active while using **AIL-DIFF**, it will not have any effect. ONLY **AIRBRAKE** controls the ailerons as flaps in the **AIL-DIFF** configuration .)*

<p>Activate twin aileron servos using AIL-DIFF.</p> <p>Note that the function defaults to no difference in down travel vs. up travel. If you want differential travel, simply adjust each side. (Ex: 90%)</p>	<p>Open the AIL-DIFF function.</p>	<p>[MODE] for 1 second. (If basic, [MODE] again.)</p> <p>[CURSOR] to AIL-DIFF. [PRESS] *</p>
	<p>Activate the function.</p>	<p>[CURSOR] [CURSOR]</p>
	<p><i>Optional: adjust the up/down travel separately for the 2 servos. (Ex: adjust to 100%.)</i></p>	<p>[CURSOR] [CURSOR] AILERON STICK [CURSOR] to 90%.</p> <p>[CURSOR] [CURSOR] AILERON STICK [CURSOR] to 90%.</p>
	<p>Close menu.</p>	<p>[END] [END]</p>
<p><i>Where next?</i></p>	<p>Adjust individual servo's SUB-TRIMS: see p. 41 and END POINTS: see p. 32. Set up AIRBRAKE mix: see p. 55. Set up ELEV-FLAP mix (only if model has a flap servo in CH6): see p. 54. Set up SNAP-ROLL Function: see p. 51. View additional model setups: www.futaba-rc.com/faq/faq-9c.html.</p>	

*If you receive an error message that **OTHER WING MIXING IS ON**, you must deactivate **ELEVON** or **FLAPERON**. see p. 44.

Using Twin Aileron Servos with a 5-channel receiver, **AIL-2** (**ACRO/GLID**):

```
[PARAMETER]
RESET:00000000
TYPE:ACROBATIC
MODUL:PCM
ATL:ON
AIL-2:CH6or7
```

AIL-2 allows **FLAPERON** and **AIL-DIFF** with a 5-channel receiver. **AIL-2** only tells the radio that you are using CH5 and CH6, not CH6 or CH7, as the second servo in **FLAPERON** or **AIL-DIFF**. You still must activate and set up the **FLAPERON/AIL-DIFF** function.

Note that selecting **CH5&6** does NOT free up CH6 to be used for other functions when using a receiver with more than 5 channels. Both 5 and 6 are dedicated to the **FLAPERON** or **AIL-DIFF** programming. [This is beneficial with four aileron servos that need to have their end points or sub-trims set separately. CH1, CH5 and CH6 are already fully set up to operate as ailerons. Mix CH7 or CH8 (the second aileron servo on the other side) into ailerons to function properly.]

Aircraft tail types (ACRO/GLID):

<p>Adjust the second aileron servo output from CH6or7 to channels CH5&6.</p> <p>Allows twin aileron servo operation with a 5-channel receiver.</p>	<p>Open the PARAMETER submenu.</p>	<p>[MODE] for 1 second. (If advance, [MODE] again.)</p> <p>[CURSOR] [CURSOR] to PARAMETER. [PRESS]</p>
	<p>Select AIL-2 and change to CH5&6.</p>	<p>[CURSOR] [CURSOR] to CH5&6.</p>
	<p>Close menu.</p>	<p>[END] [END]</p>
<p><i>Where next?</i></p>	<p>Finish setting up FLAPERON or AIL-DIFF. see <i>Twin Aileron Servos</i>: p. 41. View additional model setups on the internet: www.futaba-rc.com/faq/faq-9c.html.</p>	

There are 4 basic tail types in aircraft models:

- Simple. Model uses one elevator servo and one rudder servo (or multiple servos on a Y-harness). This is the default.
- Dual Elevator servos. Model uses 2 elevator servos. see **AILEVATOR (ACRO)** see p. 49.
- Tail-less model. Model uses 2 wing servos together to create roll and pitch control. see **ELEVON (ACRO/GLID)**. see p. 48.
- **V-TAIL**. Model uses 2 surfaces, at an angle, together to create yaw and pitch control. see **V-TAIL (ACRO/GLID)**. see p. 50.

Note: Only one of the three tail-type functions (**AILEVATOR**, **V-TAIL**, and **ELEVON**) can be used at a time. The radio provides a warning and will not allow the activation of another tail type until the first is deactivated. An error message of **OTHER WING MIXING IS ON** will display. (See the wing type example on page 44.)

Using **ELEVON (ACRO/GLID)**: used with delta wings, flying wings, and other tailless aircraft that combine aileron and elevator functions, using two servos, one on each elevon. The aileron/elevator responses of each servo can be adjusted independently. This is also popular for ground model use, such as tanks, which drive two motors together for forward, and one motor forward/one backward for turning.

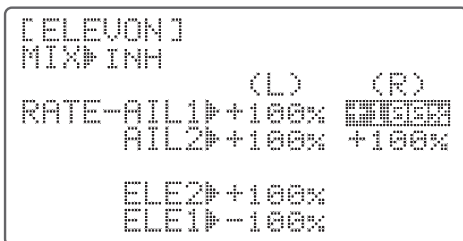

Adjustability:

- Requires use of CH1 and CH2.
- Independently adjustable aileron travel allows aileron differential.
- Independently adjustable elevator travel allows for differences in up vs. down travel.

NOTE: If **ELEVON** is active, you cannot activate **FLAPERON**, **AIL-DIFF**, or **AILEVATOR**. An error message **OTHER WING MIXING IS ON** displays and you must deactivate the last function to activate **ELEVON**.

NOTE: Be sure to move the elevator and aileron sticks to full deflection during setup. If large travels are specified, when the **AILERON** and **ELEVATOR STICKS** are moved at the same time the controls may bind or run out of travel.

(For details on setting up a complex aerobatic plane, such as “space shuttle” style controls, please visit www.futaba-rc.com/faq/faq-9c.html. Many other setup examples are also available at this location.)

GOAL of EXAMPLE:	STEPS:	INPUTS:
Activate ELEVON .	Open the ELEVON function.	for 1 second. (If basic , again.)
Adjust aileron down travel to 90% of up travel, creating aileron differential.	Activate the function.	to ELEVON .
	<i>Optional: adjust the up/down travel separately for the servos as ailerons. (Ex: down to 90%.)</i>	AILERON STICK . to 90% . AILERON STICK to 90% .
	<i>Optional: adjust the elevator travel of each servo. (Ex: right servo elev. travel to 98%, left to 105%.)</i>	to 98% . to 105% .
	Close menu.	
<i>Where next?</i>	Adjust individual servo's SUB-TRIMS : see p. 41 and END POINTS : see p. 32. Set up dual/triple rates and exponential (D/R,EXP): see p. 35. View additional model setups on the internet: www.futaba-rc.com/faq/faq-9c.html	

Dual Elevator Servos (with a rudder) (**AILEVATOR**) (**ACRO/GLID**): Many models use two elevator servos, plugged in separate receiver channels. (Flying wings without a separate aileron control use **ELEVON**. V-shaped tail models use **V-TAIL**, p. 50.

```
[AILEVATOR]
MIXPINH

RATE--AIL3▶ 50%
      AIL4▶ 50%

      ELE2▶ -100%
      ELE1▶ +100%
```

Benefits:

- Ability to adjust each servo's center and end points for perfectly matched travel.
- Ease of assembly, not requiring torque rods for a single servo to drive 2 surfaces.
- Elevators acting also as ailerons for extreme stunt flying or more realistic jet flying (optional).
- Redundancy, for example in case of a servo failure or mid-air collision.

Adjustability:

- CH2 and CH8 only. (With programmable mixing, could utilize CH5 as the 2nd elevator servo. See www.futaba-rc.com/faq/faq-9c.html for examples.) **THROTTLE-NEEDLE** uses CH8 and cannot be active simultaneously.
- Direction of each servo's travel may be reversed in **REVERSE** or the set percentages may be reversed here.
- Elevator travels independently adjustable (both directions and percent).
- Optional action as ailerons (defaults to **50%** response). This response **cannot** be activated/deactivated in flight. Setting **AIL1** and **2** to **0** disables this feature. Note: if you want this, but on/off with a switch, set **AIL1** and **2** to **0** here, and use 2 mixes – **AIL-to-ELEV** and **AIL-to-AUX2** (link/trim off, assign a switch)– to get aileron action from the elevator servos when the assigned switch is on. See p. 59.

(For details on setting up a complex aerobatic plane, such as one with 4 wing servos, full span ailerons/flaps, **AIRBRAKE**/crow etc, please visit www.futaba-rc.com/faq/faq-9c.html. Many other setups are also available.)

The **AILEVATOR** mixing function uses one servo on each of the two elevators, *and* combines the elevator function with the aileron function (unless aileron travel is set to **0**). For aileron effect, the elevators are raised and lowered opposite of one another in conjunction with the ailerons.

Once **AILEVATOR** is activated, unless you zero out the aileron figures (see below), any time you move your ailerons or any programming moves your ailerons (ie. **RUDDER-AILERON** mixing), the radio automatically commands both elevator servos to also operate as ailerons. To deactivate this action, simply set the 2 aileron travel settings to **0** in the **AILEVATOR** function. This way the elevators will work *only* as elevators.

If using the elevators as ailerons as well, be sure to move the elevator/aileron stick while checking the servo motions. If a large travel is specified, when the sticks are moved at the same time, controls may bind or run out of travel.)

GOAL of EXAMPLE:	STEPS:	INPUTS:
Activate twin elevator servos. Deactivate the elevator-acting-as-aileron portion of this function. Note: Depending upon your model's geometry, you may need to reverse one servo or set a negative percentage here.	Open the AILEVATOR function.	for 1 second. (if basic, again.) to AILEVATOR .
	Activate the function.	
	<i>Optional: adjust up/down travel when operating as ailerons. (Ex: 0.)</i>	to 0% . to 0% .
	<i>Optional: adjust total elevator travel of each servo. (Ex: right servo elevator travel to 98%, left to 96%.)</i>	to 98% . to 96% .
	Close menu.	
<i>Where next?</i>	Adjust individual servo's SUB-TRIMS : see p. 41 and END POINTS : see p. 32. Set up <i>Twin Aileron Servos</i> : see p. 44. Set up AIRBRAKE mix: see p. 55.	

Using **V-TAIL (ACRO/GLID)**:

```

[V-TAIL]
MIX INH
RATE--ELE1 95%
      ELE2 55%

RUD2 + 50%
RUD1 + 50%
    
```

V-TAIL mixing is used with *v-tail* aircraft so that both elevator and rudder functions are combined for the two tail surfaces. Both elevator and rudder travel can be adjusted independently on each surface.

NOTE: If **V-TAIL** is active, you cannot activate **ELEVON** or **AILEVATOR** functions. If one of these functions is active, an error message will be displayed and you must deactivate the last function prior to activating **ELEVON**. see the wing example on page 44.

NOTE: Be sure to move the elevator and rudder sticks regularly while checking the servo motions. If a large value of travel is specified, when the sticks are moved at the same time, the controls may bind or run out of travel. Decrease the travel until no binding occurs.

Adjustability:

- Requires use of CH2 and CH4.
- Independently adjustable travels allow for differences in servo travels.
- Rudder differential is not available. (To create rudder differential, set **RUD1** and **2** to **0**, then use two programmable mixes, **RUD-ELE** and **RUD-RUD**, setting different percents for up and down. These are your new rudder travels. Trim and link off, switch assignment null so you can't accidentally turn off rudder. see **PROG.MIX**, p. 59.)

(For details on setting up a complex plane, such as one with a v-tail AND a separate steerable nosewheel, please visit our FAQ at www.futaba-rc.com/faq/faq-9c.html. Many other setup examples are also available at this location.)

GOAL of EXAMPLE:	STEPS:	INPUTS:
Activate V-TAIL . Adjust left elevator servo to 95% travel to match to right servo's travel.	Open the V-TAIL function.	[MODE] for 1 second. (If basic , [MODE] again.) [GLOBE] to V-TAIL . [PRESS]
	Activate the function.	[CURSOR UP] [GLOBE]
	<i>optional: adjust the travels separately for the 2 servos as elevators. (Ex: set left to 95%.)</i>	[CURSOR DOWN] [GLOBE] to 95% . Repeat as necessary for other servos.
	Close menu.	[END] [END]
<i>Where next?</i>	Adjust END POINTS : see p. 41 and SUB-TRIMS : see p. 32. Set up dual/triple rates and exponential (D/R,EXP): see p. 35. Set up ELEV-FLAP mix: see p. 54. View additional model setups on the internet: www.futaba-rc.com/faq/faq-9c.html .	

Snap Rolls at the flick of a switch (**SNAP-ROLL**) (**ACRO/GLID**):

```
[SNAP-ROLL]
MIX INH(1:R/U)
RATE-AIL 100%
ELE +100%
RUD +100%
MOD FREE
SW1 NULL
SW2 NULL
```

This function allows you to execute snap rolls by flipping a switch, providing the same input every time. It also removes the need to change dual rates on the 3 channels prior to performing a snap, as **SNAP-ROLL** always takes the servos to the same position, regardless of dual rates, inputs held during the snap, etc.

Note: Every aircraft snaps differently due to its C.G., control throws, moments, etc. Some models snap without aileron; others snap on elevator alone. Most models snap most precisely with a combination of all 3 surfaces. Additionally, rate of speed and acceleration when using the snap switch will affect how the model snaps. For information on using gyros with airplanes for cleaner precision maneuvers, such as snaps and spins without over rotation, see p. 64.

Adjustability:

- *Travel*: Adjust the amount of elevator, aileron and rudder travel automatically applied.
 - *Range*: -120 to +120 on all 3 channels. Default is **100%** of range of all 3 channels.
 - *Directions*: Up to 4 separate snaps may be set up, one for each of the 4 direction choices (up/right, down/right, up/left, down/left). Each snap is fully adjustable regarding travels and direction on each of the 3 channels.
- Note**: for simplicity, the radio refers to snaps that use “UP” or positive elevator as “**U**” or “UP” snaps. This is more commonly referred to as a positive or inside snap. “**D**” or “DOWN” snaps are more commonly referred to as negative or outside snaps.
- **R/U** = Right positive **R/D** = Right negative **L/U** = Left positive **L/D** = Left negative snap roll
 - Assignment of the 2 switches (**DIR-SW1/2**) to change snap directions is fully adjustable *and optional*. If you wish to have only one snap, leave the switches as **NULL**. (If assigned, **SW1** = up/down, **SW2** = left/right.)
 - *Caution*: it is critical that you remember if you assigned switches to select the three additional snaps.
 - For example, assign **SWITCH A** for U/D snap direction, and then also assign **SWITCH A** for elevator dual rates. While flying on elevator low rate (**SWITCH A DOWN**) you pull your snap **SWITCH**. The model will:
 - use the throws set in the snap programming (the low rate elevator has no effect); and
 - be a *down* (negative/outside) snap, not an *up* (positive/inside) snap.
 - Both of these may come as a great surprise and risk crashing if you are unprepared.
 - *Safety Switch* (**SAFE-MOD**): a safety may be set up on your landing gear **SWITCH**, preventing accidental snap rolls while the landing gear is down. The safety switch is turned on and off with the landing gear **SWITCH**.
 - **ON**: the safety mechanism is activated when the landing gear **SWITCH** is in the same position as at the time this feature is changed to **ON**. Snap rolls will not be commanded even if the snap roll **SWITCH** is turned on with the gear **SWITCH** in this position. When the landing gear **SWITCH** is moved to the opposite position, snap rolls may be commanded.
 - **OFF**: activates the safety mechanism in the opposite position from the **ON** function.
 - **FREE**: the safety mechanism is completely turned off. Snaps can be commanded regardless of the gear **SWITCH POSITION**.
- Note: The location of the safety switch always follows channel 5. If channel 5 is reassigned to switch C, for example, switch C is now the safety. If channel 5 is nulled or used as the second aileron servo, the safety function will not be available.
- *Trainer Safety*: **SNAP-ROLL** is automatically disabled when the trainer function is activated.

GOAL of EXAMPLE:	STEPS:	INPUTS:
<p>Activate SNAP-ROLL. Adjust elevator travel to 55%, rudder travel to 120% in the right/up snap. Activate SAFE-MOD so snaps can not be performed when gear is down.</p> <p>Adjust rudder travel in the <i>left/down</i> snap to 105%.</p> <p><i>(Note: using negative percents can change any of the 4 snaps' directions. For example, change snap 1 to "down" by changing the elevator percent to -100%.)</i></p> <p><i>Where next?</i></p>	<p>Open the SNAP-ROLL function.</p>	<p> for 1 second.(if basic, again.)</p> <p> to SNAP-ROLL. </p>
	<p>Activate the function.</p>	<p> to OFF or ON. </p>
	<p>Adjust the travels as needed. (Ex: elevator to 55%, rudder to 120%.)</p>	<p> to 55%.</p> <p> to 120%.</p>
	<p><i>Optional: Activate SAFE-MOD. [Ex: ON when SWITCH E (9CA) or G (9CH) is down, meaning snap function is deactivated when that switch is in the down position.]</i></p>	<p> E or G up. to ON.</p> <p> snap switch.</p> <p>Notice mix reading is still OFF.</p> <p> E or G down.</p> <p>Notice MIX reading changes to ON. </p>
	<p><i>Optional: Assign switches to up/down and left/right. (Ex: Change to the left/down snap and adjust rudder to 105%.)</i></p>	<p> to A.</p> <p> to B.</p> <p> A down B down.</p> <p><i>Repeat steps above to set percentages.</i></p>
<p>Close menu.</p>	<p> </p>	
	<p>Set up programmable mixes: see p. 53. View additional setups on the internet: www.futaba-rc.com/faq/faq-9c.html.</p>	

MIXES: *the backbone of nearly every function*

Mixes are special programs within the radio that command one or more channels to act together with input from only one source, such as a stick, slider or knob.

There are a variety of types of mixes.

Types:

- *Linear:* Most mixes are linear. A 100% linear mix tells the slave servo to do exactly what the master servo is doing, using 100% of the slave channel's range to do so. An example is **FLAPERON** – when aileron stick is moved, the flap servo is told to move exactly the same amount. A 50% linear mix would tell the slave servo, for example, to move to 50% of its range when the master's control is moved 100%. (see p. 54.)
- *Offset:* An **OFFSET** mix is a special type of linear mix. When the mix is turned on (usually a flip of a switch), the slave servo is moved a set percent of its range. An example of this is **AIRBRAKE** – moving flaps, flaperons, and elevator all to a set position at the flip of a switch. (see p. 55.)
- *Curve:* Curve mixes are mostly used in helicopters, but may also be used in airplanes and gliders. An example is **THROTTLE-NEEDLE** mixing, where the in-flight needle's servo is moved, changing the mixture, as the throttle servo is moved. (see p. 56.)
- *Delay:* Delay mixes are part of a few very special functions that make the servo move to its desired range more slowly. **THROTTLE DELAY** (*simulates turbine engines, p. 57*) and the elevator delay in **AIRBRAKE** are two examples of this (see p. 55). **DELAY in HELI** (see p. 87) is another example that slows the servo movement to the trim settings for the other conditions. The 9C does not offer fully programmable delay mixes.

Essentially every feature in the radio's programming is really a mix, with all assignments/programming set up and ready to use. Additionally, the 9C **ACRO** and **GLID** programs both provide 5 linear and 2 curve fully-programmable mixes (**HELI** provides two linear and one curve) that allow you to set up special mixes to resolve flight difficulties, activate additional functions, etc.

Let's look quickly at a few examples that are features we've already covered. This may help to clarify the mix types and the importance of mixes.

Additional examples:

- Exponential is a preprogrammed curve mix that makes the servos' response more (+) or less (-) sensitive around center stick (works in conjunction with dual rate, a linear mix that adjusts the total range). see **D/R,EXP**, p. 35.
- **IDLE-DOWN** and **THR-CUT** are two **OFFSET** pre-programmed mixes. These tell the throttle servo, when below a certain point, to move toward idle an additional set percentage to help close the carburetor. see p. 33.
- **ELEV-TO-FLAP** mixing is a pre-programmed linear mix to move the flaps proportionally to elevator control, helping the model loop even tighter than it can on elevator alone. (see p. 54.)
- **THROTTLE-NEEDLE** mixing is a curve mix (like **PROG.MIX 6** and **7**) for proper in-flight needle setup. (see p. 56.)
- **THROTTLE DELAY** mixing is a pre-programmed delay mix that slows down the response of the CH3 servo. (see p. 57.)

Next, we'll get an in-depth look at some pre-programmed mixes (*mixes whose channels are predefined by Futaba for simplicity*) we've not covered yet, and last, look at the fully-programmable mix types.

ELEV-FLAP mixing (ACRO/GLID):

```

[ELEV+FLAP]
MIX>INH

RATE>↑ 50%
↓ + 50%

SUPC
POS↑UP
    
```

ELEV-FLAP mixing is the first pre-programmed mix we'll cover. This mix makes the flaps drop or rise whenever the *ELEVATOR STICK* is moved. It is most commonly used to make tighter pylon turns or squarer corners in maneuvers. In most cases, the flaps droop (are lowered) when up elevator is commanded.

Adjustability:

- Rate: -100% (full up flap) to +100 (full down flap), with a default of +50% (one-half of the flap range is achieved when the *ELEVATOR STICK* is pulled to provide full up elevator.)
- Switch: fully assignable, or null, so mix is always active.

GOAL of EXAMPLE:	STEPS:	INPUTS:
Activate ELEV-FLAP mixing. Adjust flap travel to 0% flaps with negative elevator (push) and 45% flaps with positive elevator. Set switch assignment to null so the mix is always active.	Open the ELEV-FLAP function.	for 1 second. (If basic , again.) to ELEV-FLAP .
	Activate the function.	
	Adjust the travels as needed. (Ex: 0% , to 45% .)	<i>ELEVATOR STICK</i> . to 0% . <i>ELEVATOR STICK</i> . to 45% .
	<i>Optional: change SWITCH control. Ex: change to NULL so flaps only respond to <i>ELEVATOR STICK</i> input.</i>	 to NULL .
	Close menu.	
<i>Where next?</i>	Adjust flaperons' flap travel available (FLAPERON): see p. 45. Set up AIRBRAKE (crow/butterfly): see p. 55. Set up programmable mixes (ex: FLAP-ELEVATOR): see p. 59. View additional setups on the internet: www.futaba-rc.com/faq/faq-9c.html .	

AIRBRAKE/BUTTERFLY (crow) *mixing* (ACRO/GLID):

```
[AIR-BRAKE]
  MIX INH
RATE-AIL1 100%
  ELEV 10%
  FLAP 50%
  AIL2 50%
DELAY-ELE 0%
MODE Manual
```

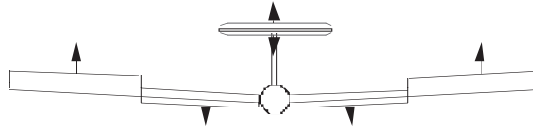























```
[BUTTERFLY]
  MIX INH
RATE-AIL1 100%
  ELEV 0%
  FLAP 0%
  AIL2 0%
DELAY-ELE 0%
PRESET 100%
```

Like **FLAPERON** and **AILEVATOR**, **AIRBRAKE** is one function that is really made up of a series of pre-programmed mixes all done for you within the radio. **AIRBRAKE** (often called “crow” or **BUTTERFLY** - see **GLID**, p. 69 for details) simultaneously moves the flap(s) (if installed), twin ailerons (if installed) and elevator(s), and is usually used to make steep descents or to limit increases in airspeed in dives.

This function is often used even on models without flaps as an easy way to use the flaperons and **FLAP-ELEVATOR** mixing together.

Adjustability:

- **Activation:** Proportional by moving the **THROTTLE STICK**, or set positions by flipping **SWITCH C** (**ACRO** only).
 - **Linear** (*Inversely proportional to THROTTLE STICK*): provides a proportional increase in amount of **AIRBRAKE** action as **THROTTLE STICK** is lowered (*when SWITCH C (ACRO) or A (GLID) is in down position*). Provides gradually more **AIRBRAKE** as you slow the engine. Includes selectable stick position where **AIRBRAKE** begins, gradually increasing to the same setting as **MANUAL** as the **THROTTLE STICK** is lowered. If you would like to have the airbrake be directly proportional to throttle stick, you will need to reverse the **THR-REV** function. Note that this changes the throttle stick direction for all models. See page 31 for instructions.
 - **MANUAL (ACRO only):** Provides **AIRBRAKE** response immediately upon switch movement, going to a pre-set travel on each active channel without any means of in-flight adjustment. (**MANUAL** option not available in **GLID** modes.)
 - **Delayed reaction:** You can suppress sudden changes in your model's attitude when **AIRBRAKE** is activated by setting the delay (**DELAY-ELE**) item, to slow down the elevator response, allowing the flaps/ailerons/elevator to all reach their desired end point together. A setting of **100%** slows the servo to take approximately one second to travel the prescribed distance.
 - **Adjustable in flight:** Using the elevator trim lever in flight will adjust the elevator settings in your airbrake rather than adjusting the model's actual elevator trim. This allows easy adjustment for any ballooning while in flight. When the airbrake switch is moved to off the trims are again adjusting the normal elevator trim.
 - **Channels controlled:** Elevator(s), twin ailerons and flap(s) may be set independently in **AIRBRAKE**, including set to **0** to have no effect.
 - **Twin aileron servos:** If **FLAPERON**, **ELEVON** and **AIL-DIFF** functions are inhibited, then **AIL1** and **AIL2** settings will have no effect.
 - If **FLAPERON** is active, the travel of the ailerons can be independently adjusted for the servos plugged into CH1 and CH6. The flap choice has no effect on the flaperons.
 - If **AIL-DIFF** is active, then CH1 and CH7 may be independently adjusted.
 - Normally both ailerons are raised equally in **AIRBRAKE**, and the elevator motion is set to maintain trim when the ailerons rise. Different amounts may be set for each aileron to correct for torque reactions and other unique characteristics of the model.
- ⚠ Be sure you understand what dropping ailerons will do when in **AIRBRAKE/BUTTERFLY**. Along with creating an enormous amount of drag (desirable for spot landings), this also creates "wash-in", a higher angle of attack where the ailerons are, and encourages tip stalling. If you are using this for aerobatic performance and not "sudden stops", consider raising the ailerons and dropping the flaps instead as shown in the diagram above.
- **Twin elevator servos:**
 - If **AILEVATOR** is active, the **AIL1** and **AIL2** settings still only affect **FLAPERON** or **AIL-DIFF** servos, NOT the elevator servos. (they would have the **AIL3** and **AIL4** settings.)

GOAL of EXAMPLE:	STEPS:	INPUTS:
Activate AIRBRAKE on a FLAPERON model. Adjust the flaperon travel to 75% , with negative elevator (push) of 25% .	Confirm FLAPERON is active.	see FLAPERON instructions.
	Open the AIRBRAKE function.	 for 1 second.(if basic ,  again.)  to AIRBRAKE . 
	Activate the function.	 Switch C in up position.   to OFF . 
	Adjust the travels as needed. (Ex: Ailerons each 75% , Elevator -25% .)	 to 75% .   to -25% .    to 75% .
	<i>Optional: delay how quickly the elevator servo responds.</i>	  to 25% . 
	<i>Optional: change the mixing from full amount upon switch to proportional to the THROTTLE STICK's proximity to idle.</i>	 to Lnear (0%) .a  THROTTLE STICK to desired 0 point.  for 1 sec., until beeps (display changes if new setting is different from prior setting).
	Close menu.	 
<i>Where next?</i>	Adjust flaperons' total flap travel available (FLAPERON): see p. 44. Set up ELEV-FLAP mixing: see p. 54. Set up programmable mixes, for example, FLAP-ELEVATOR : see p. 59. View additional model setups on the internet: www.futaba-rc.com/faq/faq-9c.html .	

THROTTLE-NEEDLE mixing (**ACRO/HELI**):

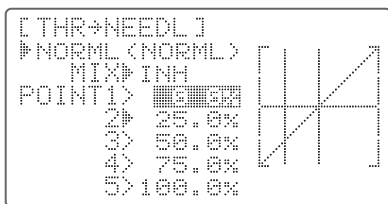

THROTTLE-NEEDLE is a pre-programmed mix that automatically moves an in-flight mixture servo (CH8) in response to the **THROTTLE STICK** inputs for perfect engine tuning at all throttle settings. This function is particularly popular with contest pilots who fly in a large variety of locations, needing regular engine tuning adjustments, *and* requiring perfect engine response at all times and in all maneuvers. Also popular to minimize flooding at idle of inverted engine installations or installations with a high tank position. Not needed for fuel injection engines, which do this automatically.

Adjustability:

- Five-point curve allows adjustment of engine mixture at varied throttle settings.
- The in-flight mixture servo must connect to receiver CH8.
- In-flight mixture servo may also be used as a second servo for tuning a twin.
- Throttle cut feature also moves the in flight needle servo.
- The CH8 knob adjusts the high throttle mixture (may be deactivated. see **AUX-CH**).
- Because both use CH8, this function cannot be used simultaneously with **AILEVATOR**.
- An acceleration (**ACCE**) function (**ACRO** only) helps the engine compensate for sudden, large amounts of throttle input by making the mixture suddenly richer, then easing it back to the proper adjustment for that throttle setting. This function requires some adjustment to best fit your engine and your flying style. Adjust engine's response until no hesitation occurs on rapid throttle input.
- Separate curves are available (**HELI** only) for normal, idle-ups 1 and 2 combined, and idle-up 3. Immediately below **THR-NEEDLE** the radio displays the curve you are editing; ex: **>NORML**; and then which condition is currently active by your switches ex: (**ID1/2**). Note that you can edit the mix for a different condition without being in that condition, to allow editing without having to shut off the helicopter's engine every time. Be sure you are editing the proper curve by checking the name after the > and *not* the one in parentheses.

GOAL of EXAMPLE:	STEPS:	INPUTS:
Activate THROTTLE-NEEDLE mixing. Adjust the points as follows to resolve a slight lean midrange problem: 1: 40% 2: 45% 3: 65% 4: 55% 5: 40%	Open the THROTTLE-NEEDLE function.	for 1 second. (If basic , again.) to THROTTLE-NEEDLE .
	Activate the function.	
	HELI only. Select the condition to edit.	as needed.
	Adjust the travels as needed to match your engine by slowly moving the stick to each of the 5 points, then adjusting the percentage at that point until the engine is properly tuned.	THROTTLE STICK . to 40% . until POINT 2 is highlighted. to 45% . to POINT 3 . to 65% . to POINT 4 . to 55% . to POINT 5 . to 40%
	ACRO only. <i>Optional: increase mixture when throttle is applied rapidly-ACCE.</i> (see above for details.)	THROTTLE STICK to idle. THROTTLE STICK full open quickly. as needed.
	HELI only: set curves for other conditions.	to condition name. to next condition to edit. Repeat above steps as needed.
Close menu.		
<i>Where next?</i>	Set up THROTTLE DELAY to imitate a jet engine's lag: see p. 57. Adjust throttle and Ch8 END POINTS : see p. 32. Set up programmable mixes, for example, AILERON-to-RUDDER : see p. 59. View additional model setups on the www.futaba-rc.com/faq/faq-9c.html .	

THROTTLE DELAY (ACRO):

```
[THR-DELAY]
MIX>INH
RATE▶██████
```

The **THROTTLE DELAY** function is used to slow the response of the throttle servo to simulate the slow response of a turbine engine. A **40%** delay setting corresponds to about a one-second delay, while a **100%** delay takes about eight seconds to respond. For helicopters, see **DELAYS**, p. 87.

This function may also be used to create a “*slowed servo*” on a channel other than throttle. This is accomplished by plugging the desired servo (Ex: gear doors) into CH3 (**THR**), throttle into an auxiliary channel such as 8, and then using some creative mixes. Please see our Frequently Asked Questions area at www.futaba-rc.com/faq/faq-9c.html for this specific example.

GOAL of EXAMPLE:	STEPS:	INPUTS:
Activate THROTTLE DELAY for a ducted-fan replica of a turbine-powered aircraft. Slow the servo response by one second.	Open the THROTTLE DELAY function.	for 1 second. (If basic , again.) to THROTTLE DELAY .
	Activate the function.	
	Adjust the RATE to match the desired servo speed. (Ex: 40% .)	to 40% .
	Close menu.	
<i>Where next?</i>	Set up THROTTLE-NEEDLE mixing: see p. 56. Adjust throttle's END POINT : see p. 32. Adjust throttle exponential (D/R,EXP): see p. 35. Set up AILEVATOR : see p. 49. Set up programmable mixes, for example, RUDDER-AILERON : see p. 59. View additional model setups on the internet: www.futaba-rc.com/faq/faq-9c.html .	

LINEAR PROGRAMMABLE MIXES (**PROG.MIX1-5**):

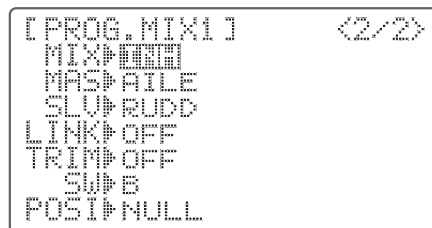

Your 9C contains five separate linear programmable mixes (**ACRO** and **GLID. HELI** has 2). (Note that mixer #6-7's mixing **RATES** are set with a 5-point curve. see *CURVE MIXES*, p. 62.)

There are a variety of reasons you might want to use these mixes. A few are listed here. All of the adjustable parameters are listed below, but don't let them scare you. For your first few times experimenting with mixes, just turn on the default mixes, adjust them how you think they need to be, then use the servo screen to check and see if you were correct. As with all functions, a sample setup follows, step by step, to assist you.

Sample reasons to use linear programmable mixes:

- To correct bad tendencies of the aircraft (such as rolling in response to rudder input).
- To operate 2 or more servos for a single axis (such as two rudder servos).
- To automatically correct for a particular action (such as lowering elevator when flaps are lowered).
- To operate a second channel in response to movement in a first channel (such as increasing the amount of smoke oil in response to more throttle application, but only when the smoke switch is active).
- To turn off response of a primary control in certain circumstances (such as simulating one engine flaming-out on a twin, or throttle-assisted rudder turns, also with a twin).

Adjustability:

- **ACRO/GLID Defaults:** The 5 programmable mixes default to the most frequently used mixes for simplicity. If you want to use one of these mixes, simply select that mix number so that the master and slave servos are already selected for you. (**HELI** mixes default to ail-to-rudd and elev-to-pitch.)

- **PROG.MIX1** aileron-to-rudder for coordinated turns
- **PROG.MIX2** elevator-to-flap for tighter loops
- **PROG.MIX3** flap-to-elevator to compensate pitching with flaps
- **PROG.MIX4** throttle-to-rudder ground handling compensation
- **PROG.MIX5** rudder-to-aileron roll coupling compensation

- *Channels available to mix:* All five mixes may use any combination of CH1-8. (CH9 is not proportional and cannot be mixed.) Offset and dials may also be set to the master channels. (see below.)

- *Master:* the controlling channel. The channel whose movement is followed by the slave channel.

- *Another channel:* Most mixes follow a control channel. (Ex: rudder-to-ailerons, 25%, no switch, corrects roll coupling.)

MASTER	SLAVE	LINK	TRIM	SWITCH	POSITION	RATE	OFFSET
RUDD	AILE	ON	OFF	<i>ANY</i>	NULL	25%	0

- *Offset as master:* To create an **OFFSET** mix, set the master as OFST. (Ex: move flaperons as flaps 20% of their total throw when **SWITCH C** is in down position.)

MASTER	SLAVE	LINK	TRIM	SWITCH	POSITION	RATE	OFFSET
OFST	FLAP	ON	<i>N/A</i>	C	DOWN	20%	0

- *Dial as master*: To directly effect one servo's position by moving a dial, set the master as the desired dial. (Ex: create a second throttle trim on left slider.)

MASTER	SLAVE	LINK	TRIM	SWITCH	POSITION	RATE	OFFSET
VR(D)	THRO	OFF	<i>N/A</i>	<i>ANY</i>	NULL	5%	0

- *Slave*: the controlled channel. The channel that is moved automatically in response to the movement of the master channel. The second channel in a mix's name (ie aileron-to-rudder).

- *Link*: link this programmable mix with other mixes.

Ex: PMIX **FLAP-ELEVATOR** mixing to correct for ballooning when flaps are lowered, but model has a V-tail. Without **LINK**, this mix only moves CH2 elevator when flap is commanded, resulting in a dangerous combination of yaw and roll. With **LINK ON**, mixing is applied to both CH2 and CH4.

MASTER	SLAVE	LINK	TRIM	SWITCH	POSITION	RATE	OFFSET
FLAP	ELEV	ON	OFF	ANY	NULL	5%	0

- *Trim*: master's trim affects slave. Not displayed if master is not CH 1-4, because 5-9 have no trim. Ex: two rudder servos. With **TRIM OFF**, rudder trim would bind the two servos. **TRIM ON** resolves this.

- *On/off choices*:

- **SWITCH**: Any of the positions of any of the 8 switches may be used to activate a mix. **Up&Cntr, Cntr&Dn** options allow the mix to be **ON** in 2 of the 3 positions of a 3-position **SWITCH**.

- **NULL**: No **SWITCH** can turn this mix **OFF**. This mix is active at all times.

- **STk-THR**: Turned on/off by **THROTTLE STICK** movement. Trigger point/direction are selectable. Ex: **OFST-to-**(gear doors) mix to open gear doors at idle, which is only active if throttle is below half.

MASTER	SLAVE	LINK	TRIM	SWITCH	POSITION	RATE	OFFSET
OFST	AUX2	OFF	NO	STk-THR	Stick at ½,  for 1 sec.	100%	0

- *Rate*: the percentage of the *slave*'s range it will move upon maximum input from the master channel. Ex: **RUDDER-AILERON** mix, 50%. Ail range=1". When rudder is moved full right, ailerons move ½".

MASTER	SLAVE	LINK	TRIM	SWITCH	POSITION	RATE	OFFSET
RUDD	AILE	OFF	OFF	<i>ANY</i>	NULL	50%	0

- *Offset*: Offsets the slave's center relative to the master. Ex: Smoke valve opens wider per throttle servo position when smoke **SWITCH** is **ON**. Smoke servo's neutral is moved down from **THROTTLE STICK** center to the bottom.

MASTER	SLAVE	LINK	TRIM	SWITCH	POSITION	RATE	OFFSET
THRO	AUX2	OFF	OFF	E	DOWN	100%	100%

GOAL of EXAMPLE:	STEPS:	INPUTS:
<p>Set up a FLAP-ELEV mix:</p> <p>ON when <i>SWITCH C</i> is in the down position.</p> <p>No elevator movement when flaps move up (spoilers), 5% elevator movement when flaps move down,</p> <p>LINK should be ON if model has twin elevator servos. Otherwise, LINK remains OFF.</p> <p><i>(Flap has no trim lever, so TRIM is not an option.)</i></p>	<p>Open an unused programmable mix. (Ex: use PROG.MIX3 since it is already set-up for FLAP-ELEVATOR.)</p> <p>Activate the function.</p> <p>Choose master and slave channels. (Ex: no need to change MAS/SLV.)</p> <p><i>Optional: set Master as OFST or VR(A-E). See above for details.</i></p> <p>Set LINK and TRIM as needed. (Ex: leave LINK OFF, TRIM not available.)</p> <p>Assign <i>SWITCH</i> and position. (Ex: change from G to C, DOWN.)</p> <p><i>Optional: set switch to STk-THR to activate mix with THROTTLE STICK. (See above for details.)</i></p> <p><i>Optional: set switch position to NULL. Makes mix active at all times. Not compatible with STk-THR.</i></p> <p>Set rates. (Ex: Lo=0%, Hi=5%.)</p> <p>Set OFFSET, if needed. (Ex: 0.)</p> <p>Close menu.</p>	<p> for 1 second. (If basic, again.)</p> <p> to PROG.MIX3. </p> <p> </p> <p>already FLAP </p> <p>already ELEV </p> <p> to desired choice.</p> <p> </p> <p></p> <p>(If TRIM is available, .)</p> <p> to C.</p> <p> to DOWN.</p> <p> to STk-THR. </p> <p> THROTTLE STICK to desired point.</p> <p> for 1 second to set.</p> <p> to NULL.</p> <p> VR(A) past center. Leave at 0%.</p> <p> VR(A) past center. to 5%.</p> <p> Leave at 0%.</p> <p> </p>
<p><i>Where next?</i></p>	<p>Adjust servo END POINTS: see p. 32.</p> <p>Setup dual/triple rates and exponential (D/R,EXP): see p. 35.</p> <p>Set up additional programmable mixes, ex: RUDDER-AILERON: see p. 59.</p> <p>View numerous additional mix setups: www.futaba-rc.com/faq/faq-9c.html.</p>	

Other Examples:

- **RUD-THR (HELI)** mix: When right rudder is applied, additional torque is needed from the motor to drive the tail left. Left rudder requires less torque. A rudder-throttle mix, positive on the left side and negative on the right, adjusts for this.
- **RUD-ELEV (ACRO/GLID)** mix: Compensate for pitching up or down when rudder is applied.
- **AIL-RUD** mix: Coordinate turns by applying rudder automatically with aileron input. All model types.
- **ELEV-PIT (HELI)** mix: compensate for the loss of lift of tilting the model.

CURVE PROGRAMMABLE MIXES (PROG.MIX6, PROG.MIX7):

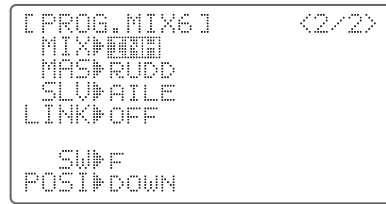
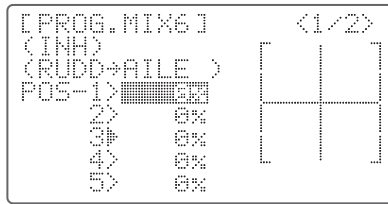

Your 9C's **ACRO/GLID** programs contain two separate curve programmable mixes. **HELI** contains one. There are a variety of reasons you might want curve mixes — usually where a linear mix doesn't fit your needs along the whole range. One pre-programmed curve mix is the **THROTTLE-NEEDLE** function. This curve is adjustable at 5 points, allowing you to adjust the motor's tuning at 5 points along its RPM range.

One programmable curve mix defaults to **RUDDER-AILERON**. A linear mix that keeps the model from rolling in knife-edge is probably too much aileron when rudder is applied in level flight. Create a curve mix and set all 5 points to match the linear mix. Inhibit the linear mix, then adjust the curve to get the right response all along the rudder channel's travel.

Adjustability: for detailed definitions, see Linear Programmable Mixes and Glossary.

- **ACRO Defaults:** The 2 programmable curve mixes default to the most frequent choices, but can be set to any channel.
 - **PROG.MIX6** rudder-to-aileron for roll coupling compensation
 - **PROG.MIX7** rudder-to-elevator for pitch coupling compensation
- **GLID/HELI Defaults:**
 - **PROG.MIX6** aileron-to-elevator for coordinated turns
 - **PROG.MIX7** elevator-to-airbrake for quicker braking (**GLID** only)
- *Master:* The controlling channel can only be a channel. Cannot be **OFFSET** or dial.
- *Trim:* not available in curve mixes.
- *Offset:* not available in curve mixes.

GOAL of EXAMPLE:	STEPS:	INPUTS:
<p>Set up a RUDD-ELEV curve mix on a model that pitches down severely at full rudder and not at all with minimal rudder input, and pitches worse on right rudder than left:</p> <p>Point 1: 25% Point 2: 8% Point 3: 0% Point 4: 10% Point 5: 28%</p> <p>ON when <i>SWITCH C</i> is down.</p> <p>LINK should be ON if model has twin elevator servos. Otherwise, LINK remains OFF.</p> <p>(Note that point 3 is 0%. Otherwise, the elevator would be retrimmed when the mix is active and no rudder input is given.)</p>	<p>Open an unused curve programmable mix. (Ex: use PROG.MIX7 since it is already set-up for RUDDER-ELEV.)</p>	<p> for 1 second. (If basic, again.)</p> <p> to PROG.MIX7. </p>
	<p>Activate the function.</p>	<p> 5 times. </p>
	<p>Choose master and slave channels. (Ex: do not change MAS or SLV).</p>	<p> </p>
	<p>Set LINK as needed. (Ex: off)</p>	<p></p>
	<p>Assign <i>SWITCH</i> and position. (Ex: change from H to C, DOWN.)</p>	<p> to C. to DOWN.</p>
	<p><i>Optional: set switch to STk-THR to activate mix with THROTTLE STICK. (See above for details.)</i></p>	<p> to STk-THR. </p> <p> throttle to desired point.</p> <p> for 1 second.</p>
	<p><i>Optional: set switch position to NULL. Makes mix active at all times.</i></p>	<p> to POSI. to NULL. </p>
	<p>Set desired percent at the stick points. (Ex: listed at left.)</p>	<p> to 25%. </p> <p>Repeat for points 2-5.</p>
<p>Close menu.</p>	<p> </p>	
<p><i>Where next?</i></p>	<p>Adjust servo END POINTS: see p. 32. Set up AILEVATOR: see p. 49. Set up linear programmable mixes, ex: RUDDER-to-Aux2 (twin rudder servos): see p. 59, or additional curve mix, ex: RUDDER-AILERON: see p. 62. View numerous mix setups: www.futaba-rc.com/faq/faq-9c.html</p>	

Special Additions, Functions, And Added Equipment Commonly Used On Powered Aircraft

Gyros: Just as torque rotates an aircraft on the runway during take-off, helicopters struggle with torque twisting the model every time throttle is applied. For many years gyroscopes have been used on model helicopters to control this. In competition aerobatics and scale aircraft competition alike, the usefulness of gyros has recently come to light. For in-depth information on gyro types, please see p. 89.

For aerobatics, gyros on rudder and elevator fix over-rotation of snaps and spins as well as tail wagging in stall turns. (Futaba offers a twin-axis gyro, GYA-352, that controls two axes with a single gyro.) For 3D aerobatics (below stall speed, such as torque rolls), heading-hold/AVCS gyros on rudder and elevator dramatically simplify these maneuvers. For scale models, gyros are frequently used to simplify take-offs and landings by keeping the model straight during throttle application.

- ⚠ Always be careful if using a heading-hold/AVCS gyro, as it will correct any change in yaw that is not caused by movement of the rudder (like making a turn with just aileron and elevator). Typically, modelers use heading-hold/AVCS settings only for specific maneuvers, such as take-offs and torque rolls, then switch to normal mode or OFF for the remainder of the flight to avoid this risk.

While the 9C's **ACRO/GLID** programming does not offer gyro-specific programming, simply adjusting the **END POINTS** of the channel that is used to control the gyro's gain will adjust the gyro's performance in flight. For details on gain and other gyro functions, please see the **HELI GYRO** programming, p. 89.

Retracts: Retractable landing gear is often used on scale models for increased realism and on high performance models to decrease drag. The gear servo is typically plugged into CH5, which defaults to a 2-position switch for simplicity.

- ⚠ Mechanical retracts require the use of a specialized non-proportional retract servo. Retract servos go from full travel one direction to full travel the other direction, then mechanically hold the gear into the locked position. A regular servo used for mechanical retracts will continue to draw full power the entire time, prematurely draining the battery and risking crash of your model. End point will **not** adjust a retract servo.

Pneumatic (air driven) retracts use a standard servo to control an air valve which directs air into or out of the retract units, moving the gear up or down. Pneumatics are easier to install but require added maintenance of the air system.

Gear Doors: Some scale models with retracts also have separate gear doors to cover the scale gear. For one example of how to operate the gear doors separately from the retracts, please visit our website: www.futaba-rc.com/faq/faq-9c.html.

Smoke Systems: Many scale and aerobatic models use smoke systems to provide increased realism or a more impressive demonstration. There are many smoke systems available, with varying types of control. Most use a servo to increase/decrease the flow of smoke fluid into the specialized smoke muffler. The oil is heated in the muffler, creating smoke.

It is a good practice to set up a "safety" that shuts off the smoke oil if the throttle is lowered below half-stick. For a detailed example of a smoke system setup, please visit our website: www.futaba-rc.com/faq/faq-9c.html.

Kill Switches: For safety reasons, it is strongly recommended that an electronic kill switch be installed in all gasoline-powered aircraft. In case of any type of in-flight problem (such as prop failure, exhaust vibrating off, throttle servo failure, radio interference), the modeler can shut the engine off quickly and safely in flight. Additionally, FailSafe (**F/S**) settings are recommended to shut the engine off in case of sufficient interference to trigger the PCM FailSafe settings.

Lastly, an electronic kill switch set to "off" prior to the aircraft's power being shut off adds an additional safety should someone accidentally turn on the mechanical kill switch on the exterior of the model.

Bomb Drops, Paratroopers, and other Released Items: Many sport and scale models include one or more of these fun add-ons. Typically, all are controlled by a simple micro-switch plugged into CH9. The switch is assigned in **AUX-CH**.

GLIDER MODEL FUNCTIONS

Please note that nearly all of the **BASIC** menu functions are the same for airplane (**ACRO** setup), sailplane (**GLID1FLP/2FLP** setups), and helicopter (**HELISWH1/SWH2/SWH4/SR-3/SN-3**) setups. The features that are identical refer back to the **ACRO** chapter. The glider **BASIC** menu does not include **IDLE-DOWN** or **THR-CUT**.

Note that in all cases where **ACRO** programming labels channel 3 as throttle, **GLID** programming labels channel 3 as **ARB** (airbrake), since airbrakes are normally operated on channel 3 in gliders. This includes **STk-THR** reading **STk-ARB**.

Gliders Setup Example p. 66.

GLID1FLP/GLID2FLP BASIC MENU

MODEL SUBMENU:

- **MODEL SELECT** See **ACRO**, p. 25.
- **MODEL COPY** See **ACRO**, p. 26.
- **MODEL NAME** See **ACRO**, p. 27.

PARAMETER SUBMENU:

- **MODEL RESET** See **ACRO**, p. 28.
- **MODEL TYPE**: Specific to **GLID** models. p. 68.
- **MODUL** (*Modulation, PPM or PCM*) See **ACRO**, p. 30.
- **ATL** [*CHANNEL 3 TRIM LEVER (THROTTLE/AIRBRAKE TRIM) function*] See **ACRO**, p. 31.
- **AIL-2** (Twin ailerons with a 5 channel receiver) See **ACRO**, p. 30.

REVERSE See **ACRO**, p. 31.

END POINT See **ACRO**, p. 32.

D/R,EXP (*Dual/Triple rates and Exponential*) See **ACRO**, p. 35.

TIMER See **ACRO**, p. 38.

AUX-CH [*Auxiliary Channel assignment (incl, ch9 servo reverse)*] See **ACRO**, p. 39.

TRAINER See **ACRO**, p. 40.

TRIM SUBMENU:

- **RESET** See **ACRO**, p. 41.
- **STEP** See **ACRO**, p. 41.

SUB-TRIM See **ACRO**, p. 42.

SERVO DISPLAY AND CYCLE SUBMENU:

- *Servo display* See **ACRO**, p. 42.
- **TEST** (*Servo cycle*) See **ACRO**, p. 42.

F/S [*FAILSAFE (loss of clean signal and low receiver battery) SUBMENU (PCM mode only)*]:

- **F/S** See **ACRO**, p. 43.
- **Battery FailSafe (F/S)** See **ACRO**, p. 43.

GLID1FLP/GLID2FLP ADVANCE MENU

Basics on wing types and tail types See **ACRO**, p. 45.

- **FLAPERON** (**GLID1FLP** only) (*aileron servos as ailerons and flaps*) See **ACRO**, p. 45.
- **FLAP TRIM** (*camber*) See **ACRO**, p. 46.
- **AIL-DIFF** (*Aileron Differential*) See **ACRO**, p. 47.
- **ELEVON** (*Flying wings*) See **ACRO**, p. 48.
- **V-TAIL** See **ACRO**, p. 50.
- **AILEVATOR**: not available in **GLID** model types.

Mixes:

- **PROG.MIX1-5** (*Linear Programmable Mixes*) See **ACRO**, p. 59.
- **PROG.MIX6-7** (*Curved Programmable Mixes*) See **ACRO**, p. 62.
- **ELEV-FLAP** See **ACRO**, p. 54.
- **BUTTERFLY** (*modified version of AIRBRAKE*) p. 69.
- **FLAP-AILE** (**GLID2FLP** only) p. 70.
- **AILE-FLAP** (**GLID2FLP** only) p. 70.
- **START OFS** (*Launch/Start setup*) p. 71.
- **SPEED OFS** (*Minimum drag setup*) p. 71.

GETTING STARTED WITH A BASIC 4-CHANNEL (Aileron/Flap/Rudder/Elevator) GLIDER

This guideline is intended to help you get acquainted with the radio, to give you a jump start on using your new radio, and to give you some ideas and direction in how to do even more with this powerful system than you may have already considered. It follows our basic format of all programming pages: a big picture overview of what we're trying to accomplish; a "by name" description of the steps to help acquaint you with the radio; and a step-by-step instruction to leave out the mystery and challenge of setting up your model.

For additional details on utilizing each function, see that function's section in this manual – the page numbers are indicated in the first column as a convenience to you.

GOAL of EXAMPLE:	STEPS:	INPUTS:
Prepare your aircraft.	Install all servos, switches, receiver per your model's instructions. Turn on transmitter then receiver; adjust all linkages so surfaces are nearly centered. Mechanically adjust all linkages to get as close as possible to proper control throws and minimize binding prior to radio set up. Check servo direction and throws. Make notes now of what you will need to change during programming.	
Select the proper MODEL TYPE for your model. (Ex: GLID1FLP .) See p. 68.	In the BASIC menu, open the PARAMETER submenu.	Turn on the transmitter. for 1 second. (If ADVANCE , again.) then to highlight PARAMETER . to choose PARAMETER .
<i>[NOTE: This is one of several functions that requires confirmation to make a change. Only critical changes such as a MODEL RESET require additional keystrokes to accept the change.]</i>	Go to MODEL TYPE .	to MODEL TYPE .
	Select proper MODEL TYPE . Ex: GLID1FLP . <i>Confirm the change.</i>	to GLID(1FLP) . for 1 second. Sure? Displays. to confirm.
	Close the PARAMETER submenu.	to return to BASIC menu.
NAME the model. P. 25. <i>(Note that you do not need to do anything to "save" or store this data.)</i>	In the BASIC menu, open the MODEL submenu.	as needed to highlight MODEL . to choose MODEL .
	Go to MODEL NAME .	(1 st character of model's name is highlighted.)
	Input aircraft's name. Close the MODEL submenu when done.	to change first character. When proper character is displayed, to move to next character and repeat. to return to BASIC menu.
REVERSE servos as needed for proper control operation. P. 31.	In the BASIC menu, open (servo) REVERSE .	4 steps to REVERSE . to choose REVERSE .
	Choose desired servo and reverse its direction of travel. (Ex: reverse rudder servo.)	to CH4: RUDD . so REV is highlighted. Repeat as needed.

GOAL of EXAMPLE:	STEPS:	INPUTS:
Adjust travels as needed to match model's recommended throws (usually listed as high rates). P. 32.	In the BASIC menu, choose END POINT .	2 steps to END POINT . to choose END POINT .
	Adjust the servos' end points. (Ex: flap servo)	to FLAP . VR(A) until travel as desired.
	Close the function.	VR(A) . Repeat as needed.
Set up dual/triple rates and exponential (D/R,EXP) P. 35. <i>(Note that in the middle of the left side of the screen is the name of the channel and the SWITCH position you are adjusting. Two or even three rates may be set per channel by simply choosing the desired SWITCH and programming percentages with the SWITCH in each of its 2/3 positions.)</i>	Choose D/R,EXP .	to D/R,EXP . to choose D/R,EXP .
	Choose the desired control, and set the first (Ex: <i>high</i>) rate throws and exponential.	to CH> . to choose CH>2 (elevator). A to up position. [Note screen reads ELEV (UP)] to D/R . ELEVATOR STICK . to set. ELEVATOR STICK . to set. <i>(Normally the same for both directions.)</i> to EXP . ELEVATOR STICK . to set. ELEVATOR STICK . to set.
	Set the second (low) rate throws and exponential.	to D/R . A to down position. Repeat above to set low rate.
	<i>Optional: change dual rate SWITCH assignment. Ex: elevator to SWITCH G with 3 positions.</i>	to SW . to G . G to center position. Repeat steps above to set 3rd rate.
	Move flap control from the VR(A) dial to the left slider [VR(D)]. (AUX-CH) p. 39.	to AUX-CH . to choose AUX-CH .
	Choose CH6 (flap).	to CH6 .
	Change primary control to VR(D) . Change other channels as needed.	to VR(D) . Repeat as required.
	Return to the home screen.	
<i>Where next?</i>	(Other functions you may wish to set up for your model.) TRAINER p. 40. Multiple wing or tail servos. See wing types and tail types: p. 44, 48. START and SPEED OFFSETS , BUTTERFLY (AIRBRAKE/crow) , and other programmable mixes p. 53. Retractable Gear, Smoke systems, kill switches, and other auxiliary channel setups: p. 39. Adjusting SUB-TRIMs to match servo centers: p. 41.	

A LOOK AT THE RADIO'S GLID-SPECIFIC FUNCTIONS STEP BY STEP. Those functions which are identical to the **ACRO** setups are referred directly to those pages.

MODEL TYPE: This function of the **PARAMETER** submenu is used to select the type of model programming to be used.

GLIDER TYPES:

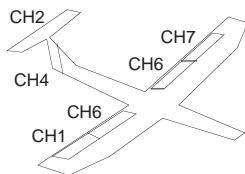

Glider1 FLP Configuration

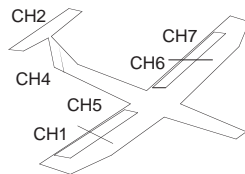

Glider2 FLP Configuration

Before doing anything else to set up a glider or sailplane, first you must decide which **MODEL TYPE** best fits your aircraft.

- **ACRO:** for some aerobatic/slope gliders, **ACRO** is a better choice because of functions it offers that the **GLID** types do not.
 - **ACRO** provides:
 - **SNAP-ROLL**,
 - **AILEVATOR** (twin elevator servo support),
 - **AIRBRAKE** (a more assignable version of **BUTTERFLY**).
 - For nitro-powered sailplanes: **IDLE-DOWN**, **THR-CUT**, **THROTTLE-NEEDLE** mixing and **THROTTLE DELAY** programming.
 - But **ACRO** lacks programming for full-span ailerons and **START** and **SPEED OFFSETS**.
- **GLID1FLP:** The **GLID1FLP MODEL TYPE** is intended for sailplanes with one or two aileron servos (or none), and a single flap servo (or two connected with a y-connector). This **TYPE** is meant to be a very simplistic version to set up a basic glider without a lot of added features. Full-span ailerons are not possible in this **MODEL TYPE**.
- **GLID2FLP:** The **GLID2FLP MODEL TYPE** supports dual flap servos that can also act as ailerons, creating full-span ailerons and flaps.

NOTE: This is one of the several functions that the radio requires confirmation to make a change.

GOAL of EXAMPLE:	STEPS:	INPUTS:
Change model 1's MODEL TYPE to GLID1FLP . <i>NOTE: This is one of the several functions that the radio requires confirmation to make a change.</i>	Confirm you are currently using the proper model memory. (Ex: 1)	On home screen, check model name and number on top left. If it is not the correct model (Ex: 1), use MODEL SELECT , p. 25.
	Open PARAMETER submenu.	[MODE] for 1 second. (If Advance menu [MODE] again.) [CURSOR] to 2nd page of menu. [GLOBE] 1 step to PARAMETER . [PRESS]
	Change the MODEL TYPE . <i>Confirm the change.</i>	[CURSOR] to TYPE . [GLOBE] to GLID1FLP [PRESS] for one second. sure? Confirmation displays. [PRESS] to confirm.
	Close.	[END] [END]
<i>Where next?</i>	Remember: Now that you changed MODEL TYPE , the model memory is almost completely reset. Only the modulation remains intact. NAME the model: p. 25. Change the receiver modulation from FM (PPM) to PCM or vice versa: see p. 28. Utilize servo REVERSE : see p. 31. Adjust servo travel with END POINT : see p. 32. Set up dual/triple rates and exponential (D/R,EXP): see p. 35.	

GLIDER ADVANCE MENU

Varied wing types and tail types (twin aileron servos, twin elevator servos, elevon, v-tail, etc). See p. 44-50 for basic information.

- **FLAPERON (GLID1FLP only)**: 2 aileron servos operate in opposite directions as ailerons and same direction as flaps. See p. 45.
- **FLAP TRIM**: provides camber movement or trimming of flaperons as flaps. See p. 46.
 - For sailplanes, this function is also used as wing camber. The amount depends on the model, but usually a small amount (less than 10%) is preferred, since too much camber produces excess drag. Don't use more than about 1/16" travel up or down for glider camber. Some airfoils, such as the RG-15, should be flown with NO reflex/camber. Be sure to consult your model's manual for guidelines.
 - *Note that even though you may make **FLAP-TRIM** active while using **AIL-DIFF**, it will not have any effect. The ONLY function that allows control of the ailerons as flaps in the **AIL-DIFF** configuration is airbrake.)*
- **Aileron Differential (AIL-DIFF)**: allows twin aileron servos to provide differential down travel from up travel. See p. 47.
- **Using a 5-channel receiver with FLAPERON and AIL-DIFF**. See **AIL-2**, p. 47.
- **ELEVON**: for flying wings. See p. 48.
- **V-TAIL**: for models with 2 servos operating together to create roll and pitch control. See p. 50.
- **AILEVATOR**: not available in **GLID** model types.

Mixes:

- **Linear Programmable mixes (PROG.MIX1-5)**: fully assignable programmable mixes with a linear response. see p. 59.
- **Curved Programmable mixes (PROG.MIX6-7)**: fully assignable programmable mixes with a curved response. See p. 62.
- **ELEV-FLAP**: pre-programmed mix creates elevator movement from the inboard flaps as well as elevators. See p. 54.
- **BUTTERFLY**: Often called crow, **BUTTERFLY** is the glider version of **AIRBRAKE**. (**BUTTERFLY** does not have the option to activate it solely from a switch, and its activation switch is not assignable. **BUTTERFLY** may only be turned on/off by **SWITCH A**, and always provides progressively more **BUTTERFLY** as the **CHANNEL 3 (THROTTLE) STICK** is lowered, or raised if used **THR-REV**, p. 31.) See **AIRBRAKE**, p. 55.

Full Span Mixing: Flap-to-Aileron and Aileron-to-Flap

- **FLAP-AILE (GLID2FLP only)**: This pre-programmed mix is used to create full span flap action on a glider with 4 wing servos. This changes the camber over the entire wing, which produces less drag than just dropping the flaps by themselves. Since **FLAP-AILE** and **AILE-FLAP** are generally utilized together, one example is shown below setting up both. NOTE: When you have **ELEV-FLAP** mixing also, the trailing edge droops with the elevators, increasing pitch response.

Adjustability:

- **RATE** range of -100 to +100. Negative setting would result in up flaperon with down flap and vice versa.
- **OFFSET** range of -30 to +30. Setting offset position sets the flap position at which the flaperons are neutral. Intended for models that do not have the flaps positioned neutral at the flap servo's center. (ie. down travel only)
- **SWITCH A-H** fully assignable.
- **POSITION** fully assignable, including **NULL** (mix always on) and **Up&Cntr** and **Cntr&Dn** to activate the mix in 2 separate positions of the same **SWITCH**. (This allows easy setup of one **SWITCH** position which is no **FLAP-AILE** or **AILE-FLAP** mixing, one with both **FLAP-AILE** and **AILE-FLAP** mixing, and one with just **FLAP-AILE** mixing.)

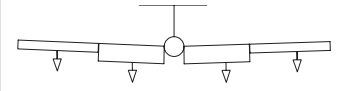
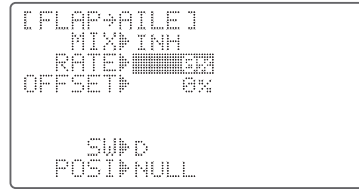
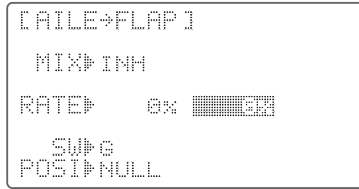
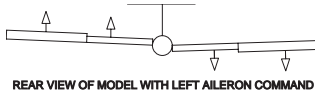

- **AILE-FLAP (GLID2FLP only):** This pre-programmed mix is used to create full span aileron action on a glider with 4 wing servos. This increases the roll rate and decreases induced drag. For normal flying, a value of about 50% is often used. For slope racing or F3B models in speed runs, you may wish to use a larger value approaching 100%.

Adjustability:

- **RATE** range of -100 to +100. Negative setting would result in opposite aileron action from flaps.
- **SWITCH A-H** fully assignable.
- **POSITION** fully assignable, including **NULL** (mix always on) and **Up&Cntr** and **Cntr&Dn** to activate the mix in 2 separate positions of the same **SWITCH**. (This allows easy setup of one **SWITCH** position which is no **FLAP-AILE** or **AILE-FLAP** mixing, one with both **FLAP-AILE** and **AILE-FLAP** mixing, and one with just **FLAP-AILE** mixing.)

GOAL of EXAMPLE:	STEPS:	INPUTS:
Turn on FLAP-AILE mixing. Set RATE to 48% , which is the portion of the total aileron travel that matches the maximum flap travel. Ex: Set up SWITCH C as follows: UP = no full span mixing. CTR = flap-ail and ail-flap DWN = flap-ail mixing only. Assign to SWITCH C center and down.	Open FLAP-AILE mixing function.	[MODE] for 1 second. (If BASIC menu, [MODE] again.) [CURSOR DOWN] to 2nd page of menu. [AILERON STICK] to FLAP-AILE . [PRESS]
	Activate the function.	[CURSOR UP] [AILERON STICK] to ON . [CURSOR DOWN]
	Set the rate. (Ex: 48%)	[AILERON STICK] to +48% . [CURSOR DOWN]
	<i>Optional: adjust the flap position at which the flaperons are zeroed.</i>	[VR(A)] or [VR(B)] VR(A) as needed. [PRESS] for 1 second to set.
	Assign the SWITCH and position. (Ex: C Cntr&Dn)	[CURSOR DOWN] to SW . [AILERON STICK] to C . [CURSOR DOWN] [AILERON STICK] to Cntr&Dn .
Close the function.	[END]	
Turn on AILE-FLAP mixing. Set rate to 100% for maximum possible flap travel with ailerons. Assign to SWITCH C center.	Open AILE-FLAP submenu.	[AILERON STICK] to AILE-FLAP . [PRESS]
	Activate the function.	[CURSOR UP] [AILERON STICK] to ON . [CURSOR DOWN]
	Set the rate. (Ex: 100% each way)	[AILERON STICK] AILERON STICK . [AILERON STICK] to +100% . [AILERON STICK] AILERON STICK . [AILERON STICK] to +100% . [CURSOR DOWN]
	Assign the SWITCH and position.	[CURSOR DOWN] to SW . [AILERON STICK] to C . [CURSOR DOWN] [AILERON STICK] to CENTER .
Close.	[END] [END]	
<i>Where next?</i>	ELEV-FLAP mixing. See p. 54. BUTTERFLY . See p. 55. Use a mix to OFFSET the flaps a set distance on a specified switch: see p. 59. View additional model setups on the internet: www.futaba-rc.com/faq/faq-9c.html	

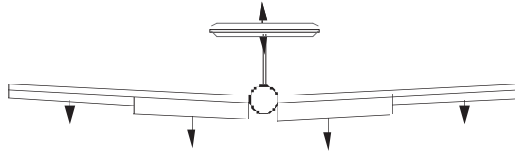

- **Launch (Start) Offset (START OFS):** The Start function is used to offset the aileron, elevator, and flap servos to the position that provides maximum lift during launch. Normally the ailerons and flaps are drooped about 20-30, with the flaps drooped slightly more to prevent tip-stalling on tow. The elevator can also be offset in order to trim out any pitch changes caused by the flap and aileron presets.

Adjustability:

- This function is only activated by flipping **SWITCH G** to the back position. If you wish to have this three-position switch above the left-hand stick (position E), you should purchase a 9CH transmitter.
- Separate adjustments for each aileron and flap servo (two flap settings for **GLID2FLP**) and for elevator.
- **RANGE** for each adjustment is -100 to +100.
- Optional assignable dial (**VR**) to adjust all 4 wing servos in unison, 1% at a time, across all 4 servos in flight.

GOAL of EXAMPLE:	STEPS:	INPUTS:
Set up a START OFS to gain maximum possible lift on launch. Each Aileron: 50%. Each Flap: 100%. Elevator: -5% to compensate. <i>Note: switch is not assignable. Must be SWITCH (9CA=G, 9CH=E.)</i>	Open START OFS function.	[MODE] for 1 second. (If BASIC menu, [MODE] again.) [CURSOR] to 2nd page. [Globe] to START OFS . [PRESS]
	Activate the function.	[Globe] Flip switch G toward you. [CURSOR] [Globe] to OFF . [CURSOR] to AIL1 .
	Set the rates. (Ex: AIL1 and 2 , 50% , FLAP1 and 2 , 100% , ELEV -5% .)	[Globe] to +50% . [CURSOR] to AIL2 . [Globe] to +50% . [CURSOR] to ELEV . Repeat for ELEV , FLP1 and 2 , AIL2 . [CURSOR]
	<i>Optional: set a knob to adjust travel of all 4 wing servos in flight.</i>	[Globe] to desired knob.
	Close the function.	[END] [END]
<i>Where next?</i>	SPEED OFS mixing. See p. 72. BUTTERFLY . See p. 55. Create a programmable mix to meet your model's setups: see p. 59. View additional model setups on the internet: www.futaba-rc.com/faq/faq-9c.html .	

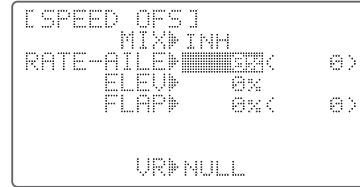
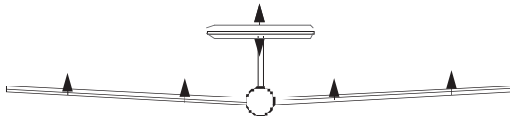

- **SPEED OFS:** The Speed function is used to offset the aileron, elevator, and flap servos for minimum drag in cruise and high-speed flight. Normally the ailerons and flaps are raised about 3-5°. (Some airfoils, notably the RG-15, have higher drag with reflex, so this function should not be used.)

Adjustability:

- This function is only activated by flipping **SWITCH G** to the forward position. If you wish to have the three-position **SWITCH** above the left-hand stick (position E), you should purchase a 9CH transmitter.
- Separate adjustments for each aileron and flap servo (two flap settings for **GLID2FLP**) and for elevator.
- Range for each adjustment is -100 to +100.
- Optional assignable dial to adjust all 4 wing servos in unison, 1% at a time across all 4 servos in flight.

GOAL of EXAMPLE:	STEPS:	INPUTS:
Set up a SPEED OFS to gain maximum possible lift on launch. Each Aileron: 5%. Each Flap: 3%. Elevator: -1% to compensate. <i>Note: switch and position are not assignable. Must be the upper 3-position SWITCH (G on 9CA, E on 9CH.)</i>	Open SPEED OFS function.	[MODE] for 1 second. (If BASIC menu, [MODE] again.) [CURSOR] to 2nd page. [GLOBE] to SPEED OFS . [PRG]
	Activate the function.	[GLOBE] Flip switch G away from you. [CURSOR] [GLOBE] to OFF . [CURSOR] to AIL1 .
	Set the rates. (Ex: AIL1 and 2 , 5% , FLAP1 and 2 , 3% , ELEV -1% .)	[GLOBE] to +5% . [CURSOR] to AIL2 . [GLOBE] to +5% . [CURSOR] to ELEV . Repeat for ELEV , FLP1 and 2 , AIL2 . [CURSOR]
	<i>Optional: set up a dial to adjust travel of all 4 wing servos in flight.</i>	[GLOBE] to desired knob.
	Close the function.	[END] [END]
<i>Where next?</i>	START OFS mixing. See p. 71. BUTTERFLY . See p. 55. Create a programmable mix to meet your model's setups: see p. 59. View additional model setups on the internet: www.futaba-rc.com/faq/faq-9c.html .	

HELICOPTER MODEL FUNCTIONS

Please note that nearly all of the **BASIC** menu functions are the same for airplane (**ACRO** setup), sailplane (**GLID1FLP/2FLP** setups), and helicopter (**HELISWH1/SWH2/SWH4/SR-3/SN-3**) setups. The features that are identical refer back to the **ACRO** chapter. The Helicopter **BASIC** menu includes the normal condition's throttle and collective pitch curves and revo. mixing. (idle-ups and throttle hold are advanced features and are in the **ADVANCE** menu).

Helicopter Setup Example	p. 74.
HELI (SWH1/2/4, SN-3, SR-3) BASIC MENU	
MODEL SUBMENU:	
• MODEL SELECT	See ACRO , p. 25.
• MODEL COPY	See ACRO , p. 26.
• MODEL NAME	See ACRO , p. 27.
PARAMETER SUBMENU:	
• MODEL RESET	See ACRO , p. 28.
• MODEL TYPE: Information specific to HELI models, including CCPM.	p. 77.
• MODUL (<i>Modulation, PPM or PCM</i>)	See ACRO , p. 30.
• ATL [<i>CHANNEL 3 TRIM LEVER (THROTTLE/AIRBRAKE TRIM) Function</i>]	See ACRO , p. 31.
REVERSE	See ACRO , p. 31.
SWASH AFR (<i>swashplate control direction and travel correction</i>) (not in SWH1)	p. 79.
END POINT	See ACRO , p. 32.
<i>Setting Up the NORMAL Condition: (TH-CV/NOR, PI-CV/NOR, REVO./NOR)</i>	p. 81.
THR-CUT (<i>specialized settings for helicopter specific models</i>)	p. 82.
D/R,EXP (<i>Specialized settings for helicopter specific models</i>)	See ACRO , p. 35.
TIMER	See ACRO , p. 38.
AUX-CH [<i>Auxiliary Channel assignment (including ch9 servo reverse)</i>]	See ACRO , p. 39.
TRAINER	See ACRO , p. 40.
TRIM SUBMENU:	
• RESET	See ACRO , p. 41.
• STEP	See ACRO , p. 41.
SUB-TRIM	See ACRO , p. 42.
SERVO DISPLAY AND CYCLE SUBMENU:	
• <i>Servo display</i>	See ACRO , p. 42.
• TEST (<i>Servo cycle</i>)	See ACRO , p. 42.
F/S [<i>FAILSAFE (loss of clean signal and low receiver battery) SUBMENU (PCM mode only):</i>]	
• F/S	See ACRO , p. 43.
• Battery FailSafe (F/S)	See ACRO , p. 43.
HELI (SWH1/2/4, SN-3, SR-3) ADVANCE MENU	
THROTTLE HOLD	p. 83.
THR-CURVE, PIT-CURVE, and REVO. MIX	p. 84.
IDLE-UPS	p. 85.
TRIMS/OFFSET	p. 86.
DELAY	p. 87.
HOVERING SETUPS	p. 88.
GYROS and GOVERNORS	p. 89.
Mixes	See ACRO , p. 53.
• PROG.MIX1-2 (<i>Linear Programmable mixes, default to AIL-RUD, ELEV-PIT</i>)	See ACRO , p. 59.
• PROG.MIX6 (<i>Curved Programmable mix, default AIL-ELEV</i>)	See ACRO , p. 60.
• THROTTLE-NEEDLE	See ACRO , p. 56.

GETTING STARTED WITH A BASIC HELICOPTER









































This guideline is intended to help you set up a basic (**SWH1**) heli, to get acquainted with the radio, to give you a jump start on using your new radio, and to give you some ideas and direction on how to do even more with this powerful system than you may have already considered. It follows our basic format of all programming pages – a big picture overview of what we're trying to accomplish; a “by name” description of the steps to help acquaint you with the radio; and then a step-by-step instruction to leave out the mystery and challenge of setting up your model.











Briefly, the typical helicopter’s controls are as follows:

- Aileron: changes cyclic lateral (roll) . Rolls the helicopter. Tilts the swashplate to the left or right. CH1.
- Elevator: changes cyclic pitch. Changes the helicopter’s angle of attack (nose up or nose down). Tilts the entire swashplate fore and aft. CH2.
- Rudder: changes the angle of the tail rotor. Yaws the helicopter left or right. CH4.
- Collective Pitch: adjusts main rotor collective [angle of the paddles], changing the main blades’ pitch. Increased collective pitch (with throttle) causes the helicopter to rise. Moves in conjunction with throttle on the *THROTTLE STICK*. CH6.
- Throttle: opens/closes carburetor. Moves in conjunction with collective pitch on the *THROTTLE STICK*. CH3.
- REVO: mix that adds rudder in conjunction with pitch. This helps compensate for rotation of the helicopter caused by the increased engine torque. (*Never* use revo. mixing with a heading-hold/AVCS gyro; the gyro already does this.)

For additional details, see that function's section in this manual — the page numbers are indicated in the first column for you..

GOAL of EXAMPLE:	STEPS:	INPUTS:
Prepare your helicopter.	Install all servos, switches, receiver per your model's instructions. Set all trims, dials and sliders to neutral. Confirm all control linkages are 90 degrees (or per instructions) from the servo horn to the ball link for proper geometry and that no slop is present. Mechanically adjust all linkages to get as close as possible to proper control throws and minimize binding prior to radio set up.	
Select the proper MODEL TYPE for your model. Ex: HELI (SWH1) . See p. 77. <i>[NOTE: This is one of several functions for which the radio requires confirmation to make a change. Only critical changes require additional keystrokes to accept the change.]</i>	In the BASIC menu, open the PARAMETER submenu.	Turn on the transmitter. for 1 second.(if ADVANCE , again.) then to highlight PARAMETER . to choose PARAMETER .
	Go to MODEL TYPE .	to TYPE .
(If the correct model type was already displayed, be sure to do a model reset to discard any unwanted settings.)	Select proper MODEL TYPE . Ex: HELI(SWH1) . <i>Confirm the change.</i> Close PARAMETER .	to HELI(SWH1) . for 1 second. sure? displays. to confirm. to return to BASIC menu.
Then, NAME the model. P. 25. <i>(You do not need to do anything to “save” or store this data.)</i>	In the BASIC menu, open the MODEL submenu.	as needed to highlight MODEL . to choose MODEL .
	Go to MODEL NAME .	(First character of model's name is highlighted.)
	Input aircraft's name.	to change first character. When proper character is displayed, to move to next character. Repeat.
	Close the MODEL submenu when done.	to return to BASIC menu.

Reverse servos as needed for proper control operation. Ex: LEFT RUDDER STICK results in leading edge of tail rotor blades moving left. Reverse to operate properly. P. 31.	In the BASIC menu, open REVERSE .	 4 steps to REVERSE .  to choose REVERSE .
	Choose desired servo and reverse its direction of travel. (Ex: reverse rudder servo.)	    to CH4: RUDD .  so REV is highlighted. Repeat as needed. 
Adjust Travels as needed to match model's recommended throws (usually listed as high rates). P. 32.	In the BASIC menu, choose END POINT .	 2 steps to END POINT .  to choose END POINT .
	Adjust the servos' end points. (Ex: flap servo)	 to ELEV .  ELEVATOR STICK .  until down travel is as desired.  ELEVATOR STICK .  until down travel is as desired. Repeat as needed. 
Activate THR-CUT . P. 82.	Open THR-CUT function.	 4 steps. 
	Activate the function. Choose desired switch and position to activate.	    to SW .  to C .  to DOWN .
	With THROTTLE STICK at idle, adjust the rate until the engine consistently shuts off, but throttle linkage is not binding. ¹	 C to down position.  THROTTLE STICK .   to RATE .  until shuts off. 
Close.		
	Set up throttle curve for normal. ² (Usually changes will not need to be made prior to first flight.) P. 81.	Open the THR-CV/NOR function. Adjust if needed. Close the function.
Set up collective pitch curve for normal as base of -4, center of +5, end of +8 to +10 degrees of blade pitch for aerobatics. ² (If just learning to fly, ask your instructor.) P. 81.	Open the PIT-CV/NOR function. Adjust each point to match desired curve. (Ex first point: 8% .) Close the function.	 to PIT-CV/NOR .   to 8% .  to next point. Repeat. 
Set up revo. mixing for normal. (For heading-hold gyros, inhibit revo.) P. 81.	Open the REVO./NOR function. Adjust to your desired starting point. (Ex: 10% .)	 to REVO./NOR .   to 10% .  to next point. Repeat. 
	Close the function.	
Confirm Gyro direction. (Note: if using a heading-hold/AVCS gyro, use the GYRO programming for proper setup. See p. 89.)	With radio on, move helicopter's tail to the right by hand. The gyro should give right rudder input (leading edge of the tail rotor blades move left). If the gyro gives the opposite input, reverse direction on the gyro unit itself.	

<p>Learn how to operate HOVERING PITCH and HOVERING THROTTLE. See p. 88.</p>	<p>Notice at half throttle, the VR(C) dial adjusts the throttle separately from the pitch. VR(A) adjusts the pitch separately from the throttle.</p>	<p> for 1 second.(If ADVANCE,  again.)</p> <p> 1 step to SERVO. </p> <p> throttle to center</p> <p> VR(C)  VR(A) center dials.</p> <p> </p>
<p>Be sure to follow your model's instructions for preflight checks, blade tracking, etc. <i>Never</i> assume a set of blades are properly balanced and will track without checking.</p>		
<p> <i>Check receiver battery voltage! Always check voltage with a voltmeter prior to each and every engine start. (Never assume being plugged in all night means your radio gear is ready to fly). Insufficient charge, binding servo linkages, and other problems can result in a dangerous crash with the possibility of injury to yourself, others and property.</i></p>		
<p>Confirm the swashplate is level at 0 travel. Adjust arms if needed.</p>		
<p>Apply full collective and check that the swashplate remained level and there is no binding. Repeat for full cyclic pitch and roll. If not, adjust as needed to correct in END POINT: see p. 32.</p>		
<p>Important note: prior to setting up throttle hold, idle-ups, offsets, etc, be sure to get your normal condition operating properly.</p>		
<p>Checking setup prior to going airborne: <i>Check voltage!</i> Then, with the assistance of an instructor, and having completed all range checks, etc, gradually apply throttle until the helicopter becomes "light on the skids." Adjust trims as needed to correct for any roll, pitch, or yaw tendencies. If the tail "wags," the gyro gain is too high. Decrease gyro gain.</p>		
<p><i>Where next?(Other functions you may wish to set up for your model.)</i></p>		
<p>THROTTLE HOLD: P. 83. SUB-TRIM p. 41 and separate trims for conditions (OFFSETS): p. 86. Governor setup: p. 89. IDLE-UP p. 85. DELAYS to ease servo response when switching idle-ups: p. 87. Rudder-to-throttle and other programmable mixes p. 59.</p>		

¹Periodically move the throttle stick to full and back down to ensure proper servo settings.

²It is critical that dials A and C be centered when the pitch and throttle curves are setup.

HELI-SPECIFIC BASIC MENU FUNCTIONS

MODEL TYPE: This function of the **PARAMETER** submenu is used to select the type of model programming to be used.

Before doing anything else to set up your model, first you must decide which **MODEL TYPE** best fits your aircraft. If your transmitter is a 9CA, the default is **ACRO**. If it is a 9CH, the default is **HELI(SW1)**.

HELICOPTER SWASHPLATE TYPES:

The 9C radios support 5 basic swashplate setups, including “single servo” (**SW1** – most helicopters use this type) and 4 types of CCPM (cyclic and collective pitch mixing). A “single servo” swashplate uses one servo for each axis: aileron, elevator (cyclic pitch), and collective pitch. CCPM helicopters utilize a combination of servos working together to achieve the 3 axes of motion. There are 4 basic CCPM types, displayed below. CCPM has several advantages, the most obvious of which is far less mechanical complexity to properly move the swashplate of the helicopter. Additionally, several servos working in unison (ex: SR3, all 3 servos together create elevator movement) dramatically increases the torque available as well as the precision and centering.

Please note that some helicopters are type SR-3 or SN-3, except off by 180 degrees. For example, the Kyosho® Caliber™ is SR-3 but with the 2 parallel servos to the rear of the helicopter, not front. If your model’s swashplate is off by 180 degrees, you will still use that swashplate type, but also use **SWASH AFR** (p.79) to adjust the functions as needed until it operates properly. Additionally, different angles of CCPM may also be created utilizing the fully assignable programmable mixes. (See our Frequently Asked Questions area at www.futaba-rc.com/faq/faq-9c.html for specific examples.)

Not operating quite like you expected? In many CCPM installations you need to either reverse the direction of a specific function (**SWASH AFR**) or reverse a single servo’s direction (**REVERSE**). See **SWASH AFR** for details.(p.79)

Swashplate Type Setting Procedure

HELISWH1 Type: Independent aileron, pitch and elevator servos linked to the swashplate. Most kits are **HELISWH1** type.

HELI SWH2 Type: pushrods positioned as shown. Elevator operates with a mechanical linkage. With Aileron inputs, the aileron and pitch servos tilt the swashplate left and right; with Pitch inputs, the aileron and pitch servos raise the swashplate up and down.

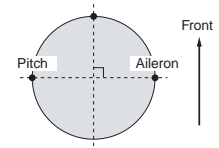

HELI SWH4 Type: pushrods positioned as shown. With Aileron inputs, the aileron and pitch servos tilt the swashplate left and right; with Elevator inputs, the servos tilt the swashplate fore and aft; with Pitch inputs, all four servos raise the swashplate up and down.

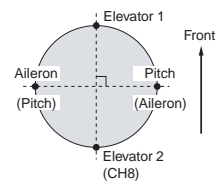



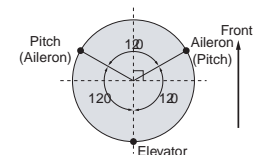



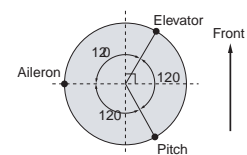



HELI SR-3 Type: pushrods positioned as shown. With Aileron inputs, the aileron and pitch servos tilt the swashplate left and right; with Elevator inputs, the three servos tilt the swashplate fore and aft; with Pitch inputs, all three servos raise the swashplate up and down.



HELI SN-3 Type: pushrods positioned as shown. With Aileron inputs, the three servos tilt the swashplate left and right; with Elevator inputs, the elevator and pitch servos tilt the swashplate fore and aft; with Pitch inputs, all three servos raise the swashplate up and down.



GOAL of EXAMPLE:	STEPS:	INPUTS:
Change the MODEL TYPE of model #3 from aircraft to 120 degree CCPM with 2 servos working in unison for collective pitch and aileron [HELI(SR-3)].	Confirm you are currently using the proper model memory. (example: 3)	On home screen, check model name and # on top left. If it is not the correct model (example: 3), see MODEL SELECT , p. 25.
	Open PARAMETER submenu.	 for 1 second. (If ADVANCE ,  again.)  to 2nd page of menu.  1 step to PARAMETER . 
	Change to the desired MODEL TYPE (example, SR3.) <i>Confirm the change.</i>	  (example: 2 steps.)  for one second. “sure?” displays.  to confirm. ¹
	Close.	 
<i>Where next?</i>	If a single servo is not operating properly, REVERSE : see p. 31. If a control is operating backwards (i.e. Elevator), see SWASH AFR , p. 79. <i>If unsure see SWASH AFR.</i>	

¹Radio emits a repeating “beep” and shows progress on screen as the model memory is being copied. Note that if the power switch is turned off prior to completion, the data will not be copied.

SWASH AFR [HELI(SWH2/4/SN-3, SR-3) only]:

```
[SWASH AFR]
RATE AIL 50%
ELE 50%
PIT 50%
```

Swashplate function rate settings (**SWASH AFR**) reduce/increase/reverse the rate (travel) of the aileron, elevator (except **SWH2**) and collective pitch *functions*, adjusting or reversing the motion of all servos involved in that function, *only when using that function*. Since these types utilize multiple servos together to create the controls, simply adjusting a servo's **REVERSE** or **END POINT** would not properly correct the travel of any one control. Since **SW1** uses one servo for each function, there is no need for **AFR** in **SW1**.





This is fairly hard to explain but easy to see, so let's set up Kyosho Caliber's swashplate settings as an example. With everything installed per factory instructions, set the model to **HELI(SR-3)**. Now let's adjust the swashplate properly.









Since aileron *always* uses no more than 2 servos, check it first. Either both operate properly (no change needed), both operate backwards (reverse the whole function), or one servo operates backwards (reverse that servo alone).

Next check elevator. Remember, the aileron servo(s) operate correctly, so if elevator does not, we should only have 2 choices left – the whole function needs to be reversed, or the servo(s) not shared with aileron need to be reversed.

Last is collective. If aileron and elevator are working properly, the only thing that could be wrong is the whole direction collective operates (reverse the whole function). In our example, **SR-3** is 180 degrees off from the swashplate of the Caliber. Therefore, it is very likely that several functions will not operate properly. The collective pitch operation is backwards; but reversing all three servos would also reverse the aileron and elevator operations. Changing the collective pitch rate, however, from **+50%** to **-50%**, will reverse the collective pitch without affecting the aileron action.

CHECKING FOR PROPER MOTION ON AN SR-3 SWASHPLATE

SR-3 Swash Type	PROPER MOTION	WRONG MOTION	HOW TO FIX
 AILERON STICK.	Swashplate tilts right.	Swashplate tilts left.	Reverse AIL setting in SWASH to -50% .
		Back of Swashplate moves up.	Ch6 servo moves incorrectly; REVERSE .
		Back of Swashplate moves down.	Ch1 servo moves incorrectly; REVERSE .
 ELEVATOR STICK.	Front of swash plate moves down; back of swashplate moves up.	Swashplate moves the opposite.	Reverse ELE setting in SWASH . (ex: +50 to -50)
		Entire swashplate moves up.	Ch2 servo moves incorrectly; REVERSE .
 RUDDER STICK.	The leading edges of tail blades rotate left.	Blades rotated right.	REVERSE the rudder servo.
 THROTTLE STICK.	Entire Swashplate lifts.	Swashplate lowers.	Reverse PIT setting in SWASH .

GOAL of EXAMPLE:	STEPS:	INPUTS:
Adjust the travel of the collective pitch from +50% to -23% , reversing the travel of all 3 servos and decreasing their travel <i>in collective pitch only</i> , on an SR-3 MODEL TYPE .	Open SWASH AFR function.	 for 1 second.(if ADVANCE ,  again.)
	Adjust PIT travel to -23 .	 to SWASH AFR . 
	Close the menu.	   to -23% .  
<i>Where next?</i>	Confirm the swashplate is level at 0 travel. Adjust arms if needed. Apply full collective and check that the swashplate remained level. If not, adjust servo's travels as needed to correct. END POINT : see p. 32. Set up the normal condition: (TH-CV/NOR, PI-CV/NOR, REVO./NOR): see p. 81. Set up D/R,EXP : see p. 35.	

Setting up the Normal Flight Condition: The Normal flight condition is typically utilized for hovering. The throttle and collective pitch curves are adjusted to provide consistent engine RPM despite the increase/decrease in collective pitch of the blades. This keeps the engine from “bogging down” under excessive load (like trying to accelerate a car on a steep hill in 5th gear) or excessive RPM under insufficient load (like flooring the throttle while in neutral), risking engine damage. As the 2 curves and revo. mixing are all interrelated, we will discuss all three first, then complete a sample setup.

Note that the normal throttle, pitch and revo curves are all available in the **BASIC** menu for simplicity. These may also be updated later in the **ADVANCE** menu with the settings for the other 4 conditions [idle-up 1 (**IDL1**), idle-up 2 (**IDL2**) and idle-up 3 (**IDL3**), plus throttle hold (**HOLD**)]. *Note:* The throttle and pitch curves for the normal condition are always on. They cannot be inhibited. The other four conditions are activated with their throttle curves or throttle hold. For idle-ups, see p. 85. For throttle hold, see p. 83.

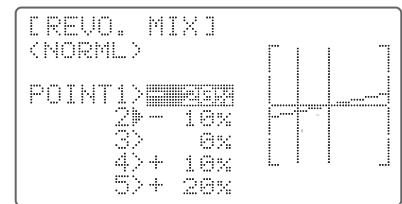
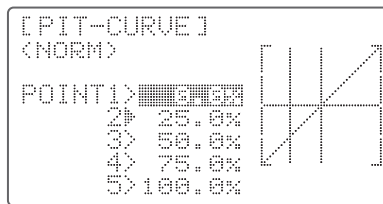
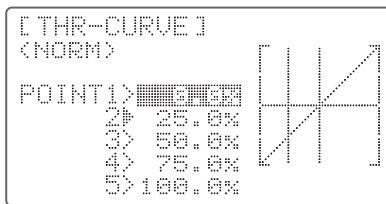

- **TH-CV/NOR:** inputs the normal (**NORM**) throttle curve, which is usually not a linear response to **THROTTLE STICK** motion. Adjusting point 3 of the curve adjusts the engine’s RPM at the **THROTTLE STICK** midpoint – the desired position for hovering. The other 4 points are then adjusted to create the desired idle and maximum engine speed, and a smooth transition in-between. For more on throttle curves, see p. 85.
- **PI-CV/NOR:** inputs the normal (**NORM**) collective pitch curve, the collective pitch curve for flight near hover. The normal collective pitch curve is adjusted to match the throttle curve, providing the best vertical performance at a constant engine speed, with a starting curve of -4 base, +5 neutral, and +8 to +10 degrees of blade pitch maximum*. You can program the response over a 5-point curve for the best collective pitch angle relative to **THROTTLE STICK** movement. For more on collective pitch curves, see p. 85.
- **REVO./NOR:** mixes collective pitch commands to the rudder (a PITCH-RUDDER mix) to suppress the torque generated by changes in the main rotor’s collective pitch angle, keeping the model from yawing when throttle is applied. **REVO.** is extremely helpful in “taming the tail” of models not using heading-hold/AVCS gyros. **NOTE:** There are three revo. mixes available: normal (**NORM**), idle-up 1 / 2 (**IDL1/2**), and idle-up 3 (**IDL3**). All 3 are adjustable in the **ADVANCE** menu. *Never* use revo. mixing in conjunction with heading-hold/AVCS gyros. For details on revo, including default points for clockwise and counterclockwise rotating rotors, see p. 85.

*These default recommendations assume you are doing forward flight. If you are just learning, please follow your instructor’s guidance. Some instructors like a +1 base point for training so that the helicopter comes down very slowly, even if your instincts pull the throttle/collective stick to the bottom in a hurry.

GOAL of EXAMPLE:	STEPS:	INPUTS:
<p>Set up Normal Flight Condition Throttle/Collective Pitch Curves and Revo.</p> <p><i>Base point:</i> Adjust base point of throttle curve until engine idles reliably on ground. Adjust base point of collective pitch curve to achieve -4 degrees of blade pitch.</p> <p>Apply throttle until the model sits 'light' on its skids. Adjust base point of REVO. until model does not rotate its nose at all.</p>	<p>Open the THR-CV/NOR function.</p> <p>Adjust the first point. (Ex: 5%.)</p>	<p> for 1 second. (If ADVANCE, again.)</p> <p> to THR-CV/NOR. </p> <p> to 5%. </p>
	<p>Open the PIT-CV/NOR function.</p> <p>Adjust the first point. (Ex: 8%.)</p>	<p> to PIT-CV/NOR. </p> <p> to 8%. </p>
	<p>Open the REVO./NOR function.</p> <p>Adjust the first point. (Ex: 4%.)</p>	<p> to REVO./NOR. </p> <p> to 4%. </p>
<p><i>Hover point:</i> Adjust collective pitch curve to +5 degrees. Ease heli into a hover. Land/shut engine off. Adjust throttle curves and rudder trim. Repeat until model hovers smoothly at half throttle.</p> <p>Rapidly apply throttle from ¼ to ½ stick. Adjust REVO. points 2 and 3 until the model does not rotate its nose up on throttle application.</p>	Adjust THR-CV/NOR .	Repeat above as needed.
	Adjust PIT-CV/NOR .	Repeat above as needed.
	Adjust REVO./NOR .	Repeat above as needed.
<p><i>High point:</i> Adjust collective pitch curve to +8 to +10 degrees. From hover, throttle up rapidly. If engine bogs, increase the throttle curve. If engine over-revs, increase the collective pitch curve at points 4 or 5.</p> <p>Apply full throttle while hovering, then descend back to hover. Adjust REVO. until the nose does not change heading.</p>	Adjust THR-CV/NOR .	Repeat above as needed.
	Adjust PIT-CV/NOR .	Repeat above as needed.
	Adjust REVO./NOR .	Repeat above as needed.
<p><i>Where next?</i></p>	<p>GYRO function: see p. 89.</p> <p>Adjust HOV-THR and HOV-PIT if needed: see p. 88.</p> <p>Setting up Throttle Hold: see p. 83.</p> <p>Setting up idle-ups 1, 2 and 3: Throttle and collective pitch curves and revo. mixing (TH-CURVE, PI-CURVE, REVO. MIX): see p. 85.</p> <p>GOVERNOR function: see p. 89.</p> <p>D/R,EXP: see p. 35.</p>	

THROTTLE CUT: The **THR-CUT** function is used to kill the engine at the end of a flight. The engine can be stopped with one touch of any switch, eliminating the need to move the trim to kill the engine and then readjust prior to each flight. The helicopter **THR-CUT** includes an ON/OFF throttle position (normally a little above idle). You must move the **THROTTLE STICK** back below the set point before the **THR-CUT** function can be reset, to avoid sudden engine acceleration. For a detailed example of throttle cut setup, see **ACRO** p. 34.

```
[THR-CUT]
MIX>INH
RATE>███
THR> 5%
SUPH
POS1>DOWN
```

Creating a throttle cut that operates only in Normal and not in any Idle-Ups:

<http://www.futabarc.com/faq/faq-9c-q506.html>

Note: Be sure to add the step of setting a trigger point by cursoring to **THR**, then putting the **THROTTLE STICK** in the desired position and pressing and holding the dial for one second. Notice that this function cannot be reversed to trigger only *above* the stick point.

HELI-SPECIFIC ADVANCE MENU FUNCTIONS

THR-HOLD: This function holds the engine in the idling position and disengages it from the *THROTTLE STICK* when *SWITCH E* (9CH) or *G* (9CA) is moved. It is commonly used to practice auto-rotation.

```
[THR-HOLD]
MIX INH
POSIN 50%

[RUDD-OFFST]
MIX INH
OFFSET 0%
```

Prior to setting up **THR-HOLD**, hook up the throttle linkage so that the carburetor is opened fully at high throttle, then use the digital trim to adjust the engine idle position. To have **THR-HOLD** maintain idle, move the *THROTTLE STICK* to the idle position, then move the hold *SWITCH* on and off and keep changing the offset value until the servo does not move. To lower the engine idle speed, or if you want to shut off, input a more negative number.

Adjustability:

- *Idling position:* Range of **-50%** to **+50%** centered about the throttle idle position to get the desired engine RPM.
- *Rudder offset:* Offsets the tail rotor pitch. Keeps the fuselage from rotating in throttle hold.
- *Time delay:* A rudder offset time delay may be set up within the **DELAY** function (see p. 87) to ease in rudder and prevent tail wag.
- *Switch assignment:* Assigned to *SWITCH G* (9CA) or *E* (9CH) down. Not adjustable.
- *Throttle curve:* Since the throttle is moved to a single preset position, no curve is available for **THR-HOLD**.
- *Collective pitch curve:* Independent curve, typically adjusted to create a blade pitch range of -4° to $+10^\circ$ to $+12^\circ$, is automatically activated with **THR-HOLD**.
- *Revo. mix:* Since revo. mix adjusts for torque from the engine, no revo. mix is available for **THR-HOLD**.
- *Priority:* The throttle hold function has priority over idle-up. Be sure that the throttle hold and idle-up *SWITCHES* are in the desired positions before trying to start the engine. (We recommend starting your engine in throttle hold for safety reasons.)
- *Gyro:* Gyro programming includes an option to have a separate gyro setting for each condition, including **THR-HOLD**. This avoids the potential problem of the user being in the wrong gyro setting when going to **THR-HOLD**, resulting in an improper rudder offset and the model pirouetting.

GOAL of EXAMPLE:	STEPS:	INPUTS:
Set up throttle hold.	Open THR-HOLD function.	for 1 second. (If basic, again.) to THR-HOLD .
Determine desired throttle position by idling engine, turn on THR-HOLD , and adjust percentage as required to reach the desired running point.	Activate the function.	to OFF .
	Set desired engine position.	to desired percent.
	<i>Optional: set up a rudder offset. (If a slowed reaction is desired, go to DELAY.)</i>	to OFF . to desired offset.
	Close.	
<i>Where next?</i>	PIT-CURVE for THR-HOLD : see p. 85. DELAY for THR-HOLD (to ease collective pitch response): see p. 87. GYRO setup: see p. 89. Setting up the Idle-Ups: Throttle and Collective pitch Curves and Revo. Mixing (TH-CURVE, PIT-CURVE, REVO. MIXING) for idle-ups: see p. 85. D/R,EXP : see p. 35.	

THR-CURVE and **PIT-CURVE**: These 5-point curves are utilized to best match the blade collective pitch to the engine RPM for consistent load on the engine. Curves are separately adjustable for normal, idle-up 1, idle-up 2, and idle-up 3. In addition, a separate collective pitch curve is available for throttle hold. Sample curves are displayed in the appropriate setup types (ex: normal flight condition, p. 81) for clarity.

Suggested defaults:

- *Normal*: Collective pitch curve that results in points 1, 3 and 5 providing $-4, +5, (+8 \text{ to } +10)^*$ degrees pitch. A throttle curve setting of 0, 30, 50, 70, 100%.
- *Idle-ups 1 & 2*: Idle-ups 1 and 2 are typically the same except for the gyro settings, with one being heading-hold/AVCS and the other being normal mode. The pitch curve will likely be similar to the normal curve above.
- *Idle-up 3*: Collective pitch curve that results in points 1, 3 and 5 providing $(-8 \text{ to } -10), 0, (+8 \text{ to } +10)$ degrees. A throttle curve of 100, 75, 50, 75, 100 to provide full throttle for inverted maneuvers.
- *Throttle Hold pitch curve*: Start with the normal pitch curve (for inverted autos, start from the idle-up 3 pitch curve), but increase the last point approximately $1-2^\circ$, if available, to ensure sufficient pitch at landing.

*(These default recommendations assume you are doing forward flight. If you are just learning, please follow your instructor's guidance. Some instructors like a +1 base point for training so that the helicopter comes down very slowly, even if your instincts pull the throttle/collective stick to the bottom in a hurry.)

Adjustability:

- Normal condition curves are editable in the **BASIC** menu for convenience.
- All curves may be adjusted in the **ADVANCE** menu.
- Automatically selected with the proper condition.
- The idle-up curves are programmed to maintain constant RPM even when the collective pitch is reduced during flight (including inverted).
- To change which condition's curve is being edited, cursor up above point 1 and change the curve named.
- For clarity, the name of the condition currently active (switched on in the radio) is shown in parentheses behind name of condition whose curve is being edited. (Example: see curve displays below. Note that the normal condition is active but the idle-up 1 condition's curves are currently being edited.)
- Idle-ups and throttle hold pitch curves may be edited even before the conditions have been made active. Activating their throttle curves activates these conditions.

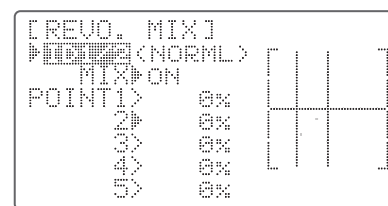
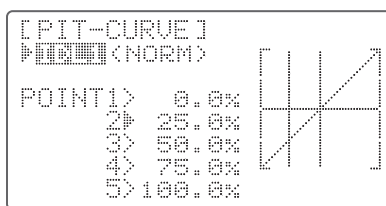
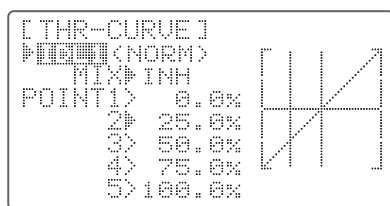

REVO. MIX: This 5-point curve mix adds opposite rudder input to counteract the changes in torque when the speed and collective pitch of the blades is changed.

Adjustability:

- Three separate curves available: normal for hovering; idle-ups 1 and 2 combined; and idle-3.
- Normal condition curves are editable in the **BASIC** menu for convenience.
- All curves may be adjusted in the **ADVANCE** menu.
- Correct mix is automatically selected in-flight with each condition and automatically activated when the throttle setup for that condition is activated in the programming (i.e. **THROTTLE HOLD** or **THR-CURVE**.)
- To change which condition's curve is being edited, cursor up above **POINT1** and select. For clarity, the name of the condition currently active (switched on at the radio) is shown in parentheses behind the name of the condition whose curve is being edited.

- Revo. mixing rates are 5-point curves. For a clockwise-turning rotor, the rudder is mixed in the clockwise direction when collective pitch is increased; for counterclockwise-turning, the opposite. Change the operating direction setting by changing the signs of the numbers in the curve from plus (+) to minus (-) and vice versa. Suggested defaults:
 - Clockwise rotation: -20, -10, 0, +10, +20% from low throttle to high.
 - Counterclockwise rotation: +20, +10, 0, -10, -20% from low throttle to high.
 - Adjust to the actual values that work best for your model.
- Revo. curves for idle-ups are often v-shaped to provide proper rudder input with negative pitch and increased throttle during inverted flight. (Rudder is needed to counter the reaction whenever there is increased torque. In inverted flight, throttle stick below half has increased throttle and negative pitch, therefore increasing torque and rotating the helicopter unless the revo. mix is also increasing appropriately.)

IDLE-UPS: additional flight conditions available specifically for helicopters. These additional flight conditions contain different throttle curves, collective pitch curves, revo. mixing, and trims (except **IDLE-3**) to make the helicopter perform certain maneuvers more easily. Lastly, the gyro and dual rate functions may be set to provide separate rates per condition selected, including one for each idle-up.

One of the most common flight conditions can easily flip from upright to inverted and back. To do so, the pitch curve is set to 0 pitch at half stick, positive pitch (climb upright) above half, and negative pitch (climb when inverted) below half stick. The throttle curve is adjusted to allow the engine to run consistently throughout the changes in pitch.

Additional idle-ups may be used to maximize the helicopter's flight characteristics in certain types of flight (i.e. fast forward motion, backward) or maneuvers (loops, rolls, stall turns), or even the same maneuver but changing from heading-hold/AVCS gyro mode to normal gyro mode. The 9C provides 3 idle-ups to allow the modeler 3 additional setups along with the normal flight condition. (Note that **IDL3** does not include governor settings.)

Adjustability:

- **SWITCH G** (9CA) or **E** (9CH) is programmed for normal (**NORM**), idle-up 1 (**IDL1**), and idle-up 2 (**IDL2**) curves. This switch/position assignment is *not* adjustable.
- Activated with the throttle curve for that condition in **THR-CURVE**.
- Curves are adjusted to maintain constant RPM even when the collective pitch is negative (inverted).
- Note that **REVO.** mixing has one curve for idle-ups 1 and 2 and a second curve just for idle-up3.
- Gyro settings may be set separately for each idle-up. (See p. 89.)
- Governor settings may be set up to follow Normal/Idle1/Idle2, but do not offer a setting to adjust for each of the 5 conditions like gyro. (See p. 89.)
- Activating **OFFSET** makes the **TRIM LEVERS** adjust the trim separately in each of the idle-up conditions.

For an example of throttle and pitch curves and revo, please see *Normal Flight Condition Setup*, p. 81.

OFFSET: Optional separate trims in addition to those for the normal condition. This function is used to automatically change the trim of a helicopter, for example, when transitioned from hover to flying at high speed. A clockwise-rotation rotor helicopter tends to drift to the right at high speed, so an aileron offset may be applied to offset the helicopter to the left. The necessary elevator offset varies with model geometry, so it must be determined by noting collective pitch changes at high speed. The rudder offset is affected by both revo. mixing and trim lever movement while in the offset function.



Adjustability:

- Complete switch assignability, plus a **CONDITION** option that creates/switches between individual trims for each of the idle-ups.
- When **OFFSET** is active (its switch is on), moving the **TRIM LEVERS** adjusts the stored offset, *not* the trims in the normal condition.
- When **OFFSET** is inactive (its switch is off), the **OFFSET** and any trim adjustments to it have no effect (model obeys the trim settings of the currently-active flight condition.)
- Defaults to **ON**.
- When **OFFSET** is inhibited, trim adjustments made in any flight condition affect all flight conditions.
- Rapid jumps caused by large offsets can be slowed using the **DELAY** function.

NOTE: Remember, offsets and revo. mixes are not recommended when using heading-hold/AVCS gyros because they conflict with the automatic corrections to trim and torque that AVCS provides.

GOAL of EXAMPLE:	STEPS:	INPUTS:
Set up separate trims for each of the three idle-up conditions. Adjust the idle-up 2 rudder trim to correct for torque at high speeds.	Open the OFFSET function.	MODE for 1 second. (If basic, MODE again.) to OFFSET .
	Change switch setting to COND	to COND .
	Select IDL2 .	to IDL2 .
	Adjust trim settings as needed. (Ex: rudder to +8%.)	 to +8%.
	Close menus and confirm difference in trims between normal and idle-up 2.	END END E (9CH) or G (9CA) from NORMAL to IDL2 . Check that rudder trim changes.
<i>Where next?</i>	DELAY: see p. 87. THR-HOLD: see p. 83. Setting up the Idle-Ups: Throttle and Collective pitch Curves and Revo. Mixing (TH-CURVE, PIT-CURVE, REVO. MIXING for idle-ups: see p. 85.	

DELAY: The Delay function provides a smooth transition between the trim positions whenever **OFFSET**, **REVO. MIXING**, or **THROTTLE HOLD** functions are turned on and off.



Adjustability:

- Separate delay times are available for aileron (**SW1**), elevator (**SW1**), and rudder, depending upon swashplate type.
- With a 50% delay setting, the servo takes about a half-second to move to its new position...quite a long time.
- In general, delays of approximately 10-15% are sufficient.

GOAL of EXAMPLE:	STEPS:	INPUTS:
Set up a delay on all 3 channels to ease the transition from one flight condition to another so there are no “hard jumps.”	Open the DELAY function.	for 1 second. (If basic , again.) to DELAY .
	Adjust AIL response as needed. (Ex: aileron to +8%.)	to +8%.
	Repeat for other channels.	to ELE . Repeat step above.
	Close menus and confirm slowed transitions.	 E (9CH) or G (9CA) from NORMAL to IDL2 . Check that servos move gradually to new positions.
<i>Where next?</i>	THR-HOLD: see p. 83. Setting up the Idle-Ups: Throttle and Collective pitch Curves and Revo. Mixing (TH-CURVE , PIT-CURVE , REVO. MIXING for idle-ups: see p. 85.	

HOVERING ADJUSTMENTS (HOV-THR and HOV-PIT):

Hovering throttle and hovering pitch are fine-tuning adjustments for the throttle and collective pitch curves individually, affecting performance only around the center point and *only in the normal condition*. They allow in-flight tweaking of the curves for ideal setup.



Adjustability:

- Rotor speed changes caused by temp., humidity, altitude or other changes in flying conditions are easily accommodated.
- Both adjustments may be inhibited if not desired.
- Both adjustments may also be set to **NULL**, temporarily turning off the knob but maintaining the last *memorized* setting.
- Adjustments may be memorized and then the knobs returned to center point to use that amount of adjustment. Allows easy use of the trimming knobs for multiple models. (Note that when memorization is repeated with the knob offset from center, the trim value accumulates.)
- Adjustments are quickly reset to the initial value by turning the dial until the trim reads 0%, memorizing, then returning the knob to its center position.
- Note that all functions, including these, assume the model hovers at half stick.
- Available in normal condition only.

GOAL of EXAMPLE:	STEPS:	INPUTS:
<p>Fine-tune hovering with the hovering adjustments. Remember these affect <i>only</i> the hovering (normal) condition.</p> <p>Adjust throttle and collective pitch curves until model hovers nicely. In flight, adjust collective pitch and throttle curves near hover point independently with HOV-THR and HOV-PIT knobs.</p> <p>Store new settings after flight.</p>	Open the HOV-THR function.	for 1 second. (If basic , again.) to HOV-THR .
	<i>Optional: change which knob adjusts each hovering curve. NULL locks in curve in last stored position.</i>	 to desired knob.
	Store the current dial settings prior to selecting another model.	for one second to store. or VR(C) to center.
	Close.	
	Open the HOV-PIT function.	to HOV-PIT .
	Store the current dial settings prior to selecting another model.	for one second to store. or VR(A) to center.
	Close.	
<i>Where next?</i>	<p>THR-HOLD: see p. 83.</p> <p>Setting up the Idle-Ups: Throttle and Collective pitch Curves and Revo. Mixing (TH-CURVE, PIT-CURVE, REVO. MIXING for idle-ups: see p. 85.</p> <p>D/R,EXP: see p. 35.</p>	

GYROS and GOVERNORS: Using electronics to take some of the complexity out of setups and flight.

What is a gyro? A gyroscope is an electronic unit that senses motion and corrects for it. For example, if the wind blows your helicopter's tail to the left, a gyro will sense that motion (and confirm that no input was given) and will correct for it.

How does it help in helicopter setup? A good gyro will totally eliminate the need for revo. mixing. The gyro will sense and correct the unwanted motion for you, so you don't have to spend time to get a complex curve operating properly.

Gyro sensor kinds: There are many different kinds of gyros. Early gyros were mechanical, with a spinning drum similar to a child's gyroscope toy. The next generation utilized a special type of crystal, called piezoelectric, which sensed the motion and provided an electrical pulse. The finest gyros at the time of this writing are SMM technology. These silicone micro machines, or computer chips, sense the motion. SMM is far more accurate and less susceptible to inaccuracies caused by temperature changes, etc.

Types of gyro responses:

- Normal: sense motion and dampen it (if the gyro rotates off course for 2 seconds, it corrects for 2 seconds).
- Heading-hold/AVCS: calculate the angle of rotation (by tracking the time/rate of change) and then provide correction until the same rotation is achieved.
- Stick priority: a feature on most high-end gyros. The more input given on the channel the gyro controls, the less sensitive the gain is automatically. This way, if you give a large input for a stall turn, for example, the gyro turns itself off and does not fight the stall turn. As you ease off the rudder, the gain increases again, minimizing tail wag and keeping the model straight. (If your gyro does not include stick priority, you can manually create it. Please see www.futaba-rc.com/faq/faq-9c.html.)

Choosing the right gyro for your skills, your helicopter, and your budget:

- Mechanical: some are still available. They are very challenging to set up and not as reliable as piezo or SMM.
- Non-Heading-Hold Piezo: these are now inexpensive gyros that are reliable and easy to set up. Some have dual rates and remote gain control to adjust sensitivity in flight. Lack heading-hold capabilities for precision flying.
- Heading-Hold Piezo: Until recently, the cream of the crop. Expensive, and more complex to set up. Adds GPS-like heading recognition. Exhibits minor difficulties with temperature drift (position setting varying with unit's temperature).
- Heading-Hold SMM: 21st Century gyro technology. Computer chip technology. Expensive, easier set up, higher durability. Significant decrease in temperature sensitivity. Many include frame rate settings to allow faster response when using specialized digital servos. Examples:
 - GY401: Simpler set up. Ideal for learning aerobatics through 3D.
 - GY502: Better centering than 401 for more advanced aerobatics. Ideal through Class III competition.
 - GY601: Exceptional center. Extremely fast response time. Requires specialized servo.

GYRO: simplifies adjusting/selecting the gyro sensitivity, and can provide more than 2 gyro gain settings. (The higher the gain, the more correction the gyro provides and the "softer" or less responsive the helicopter feels.) This function makes the best possible use of the inflight adjustable gain of most gyros..

Adjustability:

- Plug the gyro's sensitivity adjustment to channel 5 of the receiver. (not assignable)
- STD and AVCS/Heading-hold (**GY**) setup types available to simplify adjustments for AVCS/Heading-hold gyros.
- Full switch assignability or may select **Cond.** option.
- **Cond.** option provides separate gyro settings, one for each condition, automatically selected with the condition. Allows changes in gain to meet the specific needs of each flight condition.
- Each gyro setting may be set from -100 to +100 gain, equating to ATV settings of -100% to +100%.
- Dual mode gyros (heading-hold/AVCS and normal) are easily triggered to each mode by changing the gyro setting's sign. Negative settings trigger normal mode; positive settings are AVCS mode.
- Larger percentages indicate more gain, or gyro responsiveness.
- Tail wagging or shaking indicates excessive gain settings. Turn down gyro setting until wag stops.

Gain Example for AVCS/Heading-hold Gyros (**GY**)

```
[GYRO SENS] MODE→STD
MIX→INH
RATE-UP → [|||||] ←
DOWN→ 50.0x
SW→F
```

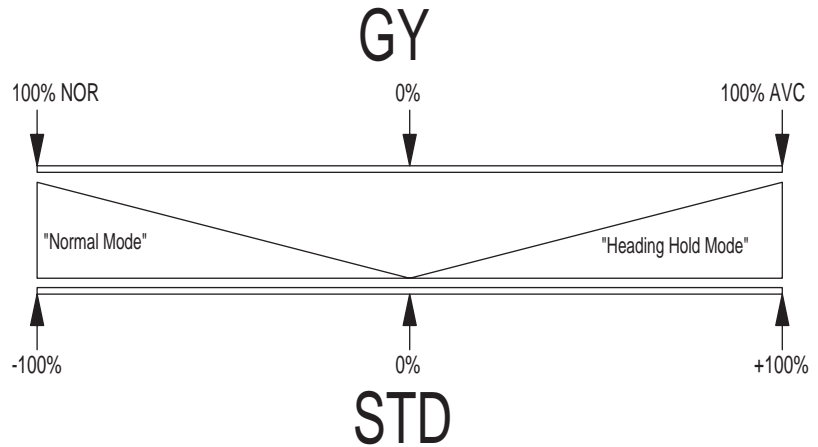

GOAL of EXAMPLE:	STEPS:	INPUTS:
Set up a heading-hold/AVCS gyro with heading-hold/AVCS setting in idle-ups 1 and 2 and normal mode setting in idle-up3 and normal.	Open and activate the GYRO function.	MODE for 1 second. (if basic , MODE again.) to GYRO .
	<i>Optional: change gyro type to Heading-hold (GY).</i>	
	<i>Optional: change switch assignment. Ex: select Cond.</i>	to SW . to Cond .
	Adjust gyro rates as needed. (Ex: NORM , IDL3 to -50% . IDL1 and 2 to +50% as starting points.)	to NORM 50% . to AVC 50% . Repeat as needed.
	Close the function.	END END
<i>Where next?</i>	GOVERNOR : see p. 91. D/R,EXP : see p. 35. DELAY : see p. 87.	

GOVERNORS:

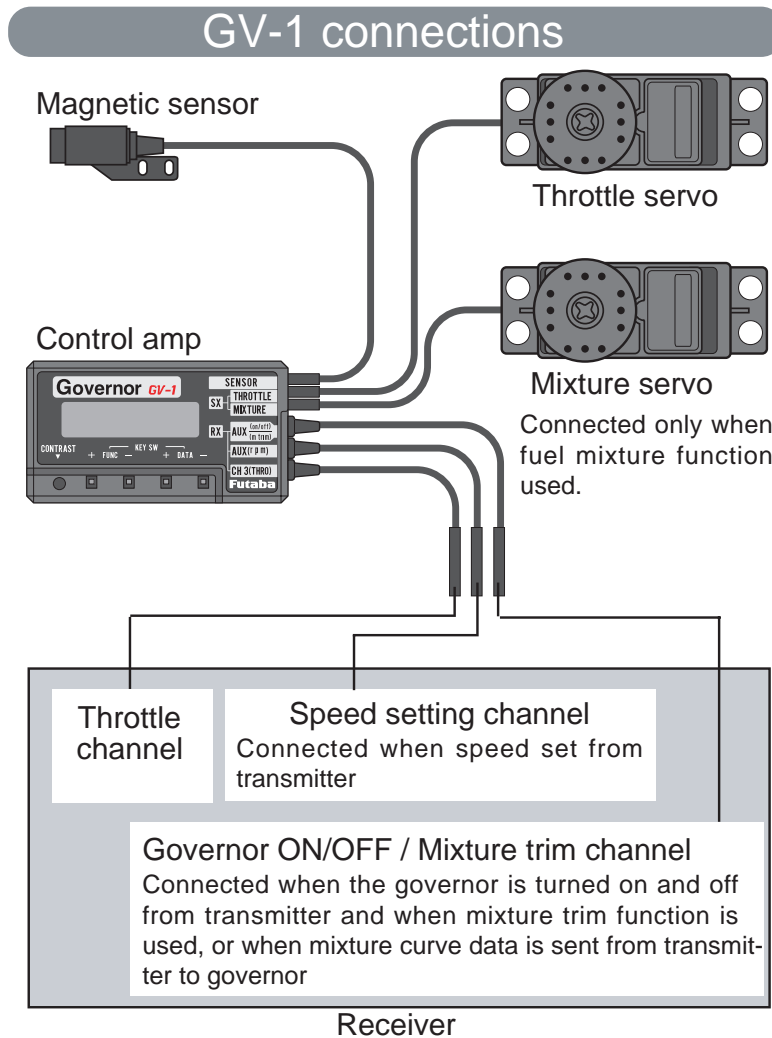

What is a governor? A governor is made up of a set of sensors which read the RPM of the helicopter’s head, and a control unit that automatically adjusts the throttle setting to maintain a constant head speed regardless of changes in pitch of blades, weather conditions, etc. Governors are extremely popular in competition helicopters due to the consistency provided.

How does it help in helicopter setup? The governor eliminates the need to spend large amounts of time setting up throttle curves, as it automatically adjusts the engine’s RPM to maintain the desired head speed.

GOVERNOR: The Governor mixing function is used to adjust the GV-1 (Governor) speed settings (rS1, rS2, rS3) from the transmitter. (If you are using a different governor, follow the manufacturer's instructions.)

```
[ GOVERNOR ] <1/2>
<INH>
RATE-UP [|||||] +
CNTR 50.0%
DOWN [|||||] 100.0%

SW C
```

```
[ GOVERNOR ] <2/2>
MIX [|||||]
CUT-CH CH7
DIR +Limit
```

Adjustability:

- On/off may be separate from speed switching by plugging governor on/off into ch8 and changing **CUT-CH** setting.
- If using separate on/off, switch assignment is totally adjustable. Be *careful* not to assign governor off to a condition switch if you want the governor to function in that condition.

- Speed switching and governor ON/OFF may be together using one switch or ON/OFF switching may be performed using an independent switch/channel.
- When speed setting control uses CH7 and separate ON/OFF switch is not used, CH8 can be used for other functions.
- In-flight adjustment of the head speed (for easy adjustment during tuning) may be created using an additional channel and a programmable mix. See www.futaba-rc.com/faq/faq-9c.html for details.

⚠ The GV-1 controls throttle when it is active, so the throttle will not obey any FailSafe settings preset for throttle in the transmitter. Always set the FailSafe setting for the GV-1's on/off channel to OFF. This way the governor is shut off and the throttle obeys the FailSafe throttle commands.

Expert Tip: Mounting the GV-1 to the counter gear instead of the fan dramatically simplifies installation in many models.

Setting example: When speed and ON/OFF are using one switch:

Governor Speed	Switch Position (Switch C or G)	Rate (%)	Adjustment from Tx.
RS1: OFF	Up or NORM	0	Use up to 0%. (Governor speed display reads “off”.)
RS2: 1400	CNTR or IDL1	50	Speed adjusted by raising and lowering rate.
RS3: 1700	DOWN or IDL2	100	Speed adjusted by lowering rate.

- ⚠
- The relationship of the governor speed setting rS1~rS3 and the switch positions conforms to the table above.
 - In throttle hold, always check that the governor is *off*.
 - If the speed value rises when the cut switch is activated, reverse the “DIR” setting from **+LIMIT** to **-LIMIT** or vice versa.

GOAL of EXAMPLE:	STEPS:	INPUTS:
<p>Set up a GV1 governor to use both channels into the receiver and switch between the governor settings automatically when changing conditions.</p> <p>Consider setting the battery FailSafe settings and other helpful functions on the GV-1 itself.</p>	<p>Open and activate the GOVERNOR function.</p>	<p> for 1 second.(If basic, again.)</p> <p> to GOVERNOR. </p> <p> to ACT.</p>
	<p><i>Optional: change cut-off channel to channel 8 and assign switch and direction for on/off (channel 8).</i></p>	<p> to CH8.</p> <p> to - if opposite switch direction is desired.</p> <p> to desired SWITCH.</p>
	<p><i>Optional: change switch assignment to select governor settings. Ex: select switch that selects the conditions.</i></p>	<p> to SW.</p> <p> to G. </p>
	<p>Adjust governor speed settings per switch position or condition as needed. (Ex: defaults are fine.) Allows head speed adjustment from transmitter.</p>	<p> to each SWITCH position.</p> <p> or as needed.</p> <p> to next SWITCH position. Repeat.</p>
	<p>Close the function.</p>	<p> </p>
<p><i>Where next?</i></p>	<p>GYRO: see p. 89.</p> <p>Adjust FailSafe (F/S) settings (p. 43).</p> <p>Adjust idle-up 3 collective pitch curve for same rates of climb upright/inverted. See p. 85.</p> <p>Adjust elevator/aileron response to fit your flying style: see D/R,EXP and END POINT/SWASH AFR: pp. 35, 32, 79.</p>	

GLOSSARY

3D: Common name for certain types of aerobatic maneuvers. Aircraft: flying below the model's stall speed, such as torque rolls. Helicopters: combining 2 or more maneuvers, such as rolling loop.

4.8V: 4.8 volt battery pack, made of 4 Ni-Cd 1.2V cells. See *Accessories*.

5-cell: 6.0 volt battery pack, made of 4 alkaline cells or 5 Ni-Cd cells. See *Accessories*.

6V (6Volt): battery pack, made of 4 alkaline cells or 5 Ni-Cd cells. See *Accessories*.

ACCELERATION: a delay mix which richens engine mixture and then returns to normal to compensate for abrupt throttle changes. See **THR-NEEDLE**.56

Accessories: additional optional items which may be used with your 9C.10

ACRO: model type designed for use with powered aircraft. Selected in the **MODEL** submenu under **TYPE**29

ACRO vs **GLID** comparison.29

ACT. Active. Make a feature able to be utilized. Opposite of **INH**. Only visible in certain features.

Adjustable Function Rate: see **SWASH AFR**.

Adjustable Servo Travel (AST): a specific type of end point adjustment. See **END POINT**.

Adjustable Travel Limited (ATL): End point adjustment for low end only, for throttle channel. See **ATL**.

Adjustable Travel Volume (ATV): an older, less specific term for end point adjustment. See **END POINT**.

ADVANCE menus: Specific menus for each model type which allow the modeler to access and program the radio's more advanced features.

AFR: Adjustable function rate. Used only in **HELI** model types with CCPM heads. See **SWASH AFR**.

AIL-2: second aileron servo assignment. See *Twin aileron servos*.

AIL1/2/3/4: Designation for the individual servos that are being commanded by the aileron command. Ex: when using ailevators, the two elevator servos are also acting as ailerons 3 and 4 (unless you set their values to **0**). See *Twin aileron servos* and *Twin elevator servos*.

Aileron: surface that controls the roll of the model. Also called cyclic roll on a helicopter.

Aileron-to-flap mixing: Mixing used to create full-span aileron action. Not a preprogrammed mix. See *Programmable mix*. This is the default setup of one mix in **GLID**.

Aileron-to-rudder mix: Mixing that automatically creates a "coordinated turn". Not a preprogrammed mix. See *Programmable mix*. This is the default setup of one curve mix in **HELI / GLID**.

Aileron Differential: Decreased down aileron travel when compared to up aileron travel. Minimizes "dragging" the low wing and creates more axial rolls. See *Twin aileron servos*.44

Ailevator: two elevators on separate channels, also capable of acting as additional ailerons. See *Twin elevator servos*.

AILEVATORS: (ACRO) Twin elevator servos plugged into separate channels, used to control elevator with the option to also act as ailerons in conjunction with the primary ailerons.49

Airbrake-to-elevator mixing: (**GLID**) Applies up or down elevator when airbrakes are deployed, correcting for any pitch change from the added drag. Not a preprogrammed mix. See *Programmable mix*.

Airbrake: (**GLID**) Leading edge flaps on gliders, controlled by *CHANNEL 3 (NORMALLY THROTTLE) STICK*.

AIRBRAKE: (ACRO) Combines elevator, flap, and optionally spoilers to suddenly slow the model for spot landings. May be triggered by *THROTTLE STICK POSITION*. For similar glider programming, see **BUTTERFLY**.55

AMA: Academy of Model Aeronautics. Non-profit organization governing model aircraft flight in the US.5

AST: Adjustable Servo Travel. See **END POINT**.

ATL: Adjustable Travel Limited. Standard type of trim used for throttle, where the trim is effective only in the idle portion of the *THROTTLE STICK POSITION*. Normal trims affect the entire travel of the servo (ex: elevator trims), but **ATL** trims only the low end of the throttle movement, allowing throttle idle adjustments that don't over-drive the servo at full throttle.31

ATV: Older, less clear terminology for end point adjustment. See **END POINT**.

Autorotation: The ability of a helicopter to land safely without engine power, using the stored energy in the blade's rotation to produce lift for flaring.

AUX-CH: Auxiliary channel setup. Used to assign which *KNOBS/SWITCHES/SLIDERS* control channels 5-9. Includes CH9 servo reverse. Also allows assignment of a channel to mixing only (assigned as **NULL**), with no primary control.39

Backup battery: battery used to protect data storage in case of removal of master transmitter battery. In most Futaba radios, including the 9C, EEPROM data storage is used, so no backup battery is used or needed.

BACKUP ERROR: transmitter's hard-coded memory has been lost. Send for service immediately.19

Base-Loaded antenna: also called Whip antenna. Aftermarket equipment not approved by Futaba.

Basic model setups: guidelines to setting up the most basic models of each type. **ACRO** 22
GLID 61
HELI 74

BASIC menus: Specific menus with most commonly used features for each model type. **ACRO** 25
GLID 68
HELI 74

Battery care and charging. (Charging the Ni-Cd batteries)14

Battery FailSafe: determines how the receiver indicates an airborne pack low-battery warning. Defaults: 56% throttle, requires throttle to idle to override. To adjust the warning point, set a *THROTTLE STICK POSITION* in **F/S**.43

BEEP: tone emitted by transmitter to signify a variety of situations. See *Error messages*.

Binding: friction in a joint exceeding the movement of the linkage. Sticking or inability to continue movement. The servo continues to attempt to move the surface beyond its power/capabilities, rapidly draining battery power as it continues to struggle.

Brake flap mixing: (**GLID**) Three mixes: brake flap- to-elevator, to-aileron and to-speed flaps. 1) compensate for unwanted reaction to lowering the brake flap, 2) increase brake flap area by including the flaperons, and 3) add lift to increase maneuverability. Not a preprogrammed mix. See *Programmable mix*.

Buddy Box: see Trainer box.

BUTTERFLY: (**GLID**) [also called crow, **AIRBRAKE (ACRO)**]. Activates up flaperons and down flaps for gliding speed control without spoilers or airbrakes. Note: More adjustable programming is available in **ACRO, AIRBRAKE**.55

CAMPac: Optional extended data storage module. Futaba stock # DP16K.10

CCPM: Cyclic (pitch and roll) Collective Pitch Mixing. Multiple servos work in unison on the helicopter's head to create one or more of the control functions. Ex: 3 servos set at 120 degrees operate the entire head. The 2 forward servos work together to rotate both the blade's pitch and the roll cyclic (aileron) in a **SR3** head type. See **MODEL TYPE, HELI**.

CH5&6: setting in **AIL-2** that allows the second aileron servo to be in channel 5. See *Twin aileron servos*.

CH6 or 7: default setting in **AIL-2**. Second aileron servo is in channel 6 or 7 depending on function used. See *Twin aileron servos*.

Channel 9 switch selection and direction control: See **AUX-CH**.39

Channel delay: see **THROTTLE DELAY (ACRO)** and **DELAY (HELI)**.

Charge: to increase the electrical energy, measured as voltage, available in a battery pack. See *Battery care and charging*.

Condition: (**HELI**) separate flight setup that has significant adjustability separate from the basic model setup. See **IDLE-UP 1, 2, 3** and **THROTTLE HOLD**.

Contact information, North American Service Center.3

Copy model: see **MODEL COPY**.

Crow: see **BUTTERFLY (GLID)** and **AIRBRAKE (ACRO)**.

Cursor: See **SELECT BUTTONS**.

Curve Mix: a mix that does not have the same reaction at all points along the master channel. See **Programmable mix**.

Cyclic: horizontal controls on a helicopter. Cyclic pitch is typically called elevator. Cyclic roll is typically called aileron.

Data reset: erase all data in a specific model. See **RESET**.

DELAY: (HELI) slows the servo's reaction time when changing from one condition to another. Eases any "jumps" in transition from one pitch setting to another, etc. Also see **THROTTLE DELAY**, p. 57 (**ACRO**).87

DELAY-ELE: (ACRO) portion of **AIRBRAKE** that slows the input of the elevator to avoid sudden jumps in pitch. See **AIRBRAKE**.

Delta peak charger: common name for a specialized charger designed and required to properly peak charge both NiMH and NiCd batteries, actually called a Zero Delta V Peak Charger. See **Battery Care and Charging**.

Dial: transmitter's rotary control and button used in various ways during programming.11

Dial mix: mix that uses a knob or slider as the master control, moving the slave servo based upon the movement of the knob or slider. See **Prog. mix**.

Differential: uneven movement in each direction of a control surface. Usually used when discussing ailerons or when describing an undesirable unevenness in movement of other controls. See **Twin aileron servos**.

Diode: an electronic device which only allows current to flow one direction. Used to protect radio against power surge and reversed polarity during charging.14

DIR-SW: switches that change between the 4 separate directions of snaps available. See **SNAP ROLL**.

Discharge: to deplete the electrical energy in a battery pack, usually to its lowest safe voltage, for storage or as a part of regular maintenance. See **Battery care and charging**.

DP16K: see **CAMPac**.

DSC: direct servo control. Programming and cable combination which allows operation of all receiver channels and functions without the transmitter transmitting. Plugs into trainer port of transmitter and special plug on receiver. Leave power off for both transmitter and receiver. Only the R149DP and R309DPS receivers currently support **DSC**.

Dual aileron servos: (**ACRO / GLID**) a model using 2 servos on 2 separate channels to operate ailerons. May include flaperon action or aileron differential. See **Twin aileron servos**.44

Dual elevator servos: (**ACRO / GLID**) a model using 2 servos on 2 separate channels to operate elevators. Includes elevon, V-tail, ailevator. See **Twin elevator servos**.49

Dual rates (**D/R,EXP**): reduce/increase the servo travel by flipping a switch (or by stick position). Used to make model more comfortable to fly in different maneuvers. 9C supports triple rates by simply assigning dual rates to 3 position switches. Includes exponential function, see **EXP**.35

Elapsed Time Counter reset: see **TIMER**.38

ELE1/2/3/4: designation for the individual servos that are being commanded by the elevator command. Ex: when using elevon, the two wing servos are acting as elevators 1 and 2. See **Twin elevator servos**.

Elevator: surface which controls the model's rate of climb or descent. Also called cyclic pitch on helicopters.

Elevator-to-airbrake mix: (**GLID**) used to allow the model to loop even tighter on elevator input by having airbrakes work with elevators. Not a preprogrammed mix. See **Programmable mix**. This is the default programming for one curve mix in **GLID**.

Elevator-to-flap mix: (**ACRO / GLID**) Used to apply flaps along with elevators to increase lift, allowing modeler to fly at slower speeds, make tighter loops or turns, etc. Not a preprogrammed mix. See **Programmable mix**. This is the default setting of one mix in **ACRO** and **GLID**.

Elevator-to-pitch mix: (**HELI**) used to adjust pitch to counter the loss of angle of attack when elevator input is given. Not a preprogrammed mix. See *Programmable mix*. This is the default setting of one mix in **HELI**.

ELEVON: flying wing configuration with 2 servos working together to create both aileron and elevator action. See *Twin elevator servos*. 48

Elevons: two surfaces, one on each wing, which work as both ailerons and elevators. See **ELEVON**.

END BUTTON: control button used during programming to return to previous menu or close menu altogether.

END POINT: often abbreviated EPA. Adjusts the total travel in each direction of proportional *servos* regardless of their control assignment. Ex: adjustment to **AIL** channel will adjust only the servo plugged into channel 1 even if being used as one of two flaperons or elevons. Note: End point is not an absolute; mixing can still drive the servo farther than this setting. 32

Engine cut: see **THR-CUT**.

EPA: see **END POINT**.

Error messages: warnings/cautions provided by the radio when potential problems may exist. 19

Exponential (**D/R,EXP**): adjustment to the relationship of *STICK MOVEMENT* to servo movement, typically used to soften overly sensitive models around center. 35

FailSafe (**F/S**): sets servo positions when interference is encountered or signal is lost. Available only in PCM transmission mode. Also includes Battery FailSafe settings. 43

FLAP1/2/3/4: designation for the individual servos that are being commanded by the flap commands. Ex: when acting as flaperons, the two aileron servos are ailerons 1 and 2 and also flaps 1 and 2 (unless you set their values to 0, then they move only as aileron no matter what flap commands are given). See *Twin aileron servos* and *Twin elevator servos*.

Flap-to-aileron mix: (**ACRO / GLID**) used to create full span flap reaction in flight. Not a preprogrammed mix. See *Programmable mix*. This is the default setup of one mix in **GLID**.

Flap-to-elevator mix: (**ACRO / GLID**) used to counteract unwanted changes in pitch when flaps are deployed. Not a preprogrammed mix. See *Programmable mix*. This is the default setup of one mix in **ACRO** and **GLID**.

FLAPERON: one servo on each aileron, plugged into channels 1 and 6, which operate both as ailerons and as flaps. See *Twin aileron servos*. 44

FLAP-TRIM: Adjustment of central position of flaperons, default assigned to **CHANNEL 6 KNOB**. May also be used as primary or only control of flaperons acting as flaps, or other mixes may be set up. See *Twin aileron servos*. 46

Frequency: channel on which radio transmits. 17

Frequency band: In the entire spectrum, transmissions are designated in terms of “frequency bands” which exhibit similar properties. In the US, specific frequencies within the 72MHz band are regulated by the FCC to be used solely for remote control aircraft. 50MHz band is available for model use by those holding a HAM amateur radio operator’s license. 75MHz is solely for remote control ground models. 27MHz is legal for air or ground use. To change bands on the 9C, simply purchase and install a module on the proper band. Receiver band **MUST** be changed by a service center. 17

Fuel mixture control: (**ACRO / HELI**) see **THROTTLE-NEEDLE**.

FUNC: function mode of **TRAINER**, allows student radio to use the computer programming for that channel in the master radio. Ex: allows a student with a 4-channel transmitter to fly an 8-servo aerobatic plane or a 5-servo helicopter. See **TRAINER**.

Gain: the responsiveness or amount of control given the gyro. On a high gain, the gyro is very active and overrides nearly all other actions. Too high a gain may result in “wagging” at the surface as the gyro over-corrects repeatedly in each direction. See **GYRO SENS**.

Gear doors: covers for retractable landing gear, may be operated separately from landing gear on some models. . . . 64

GLID: model type, glider. 68

Governor: electronic device that reads the speed at which the head is spinning, and adjusts the throttle servo to maintain the desired speed.

GOVERNOR: (HELI) programming which eases the setup of the GV-1 governor.	89
GV-1: part number/name for Futaba's electronic governor. See <i>Gyros and Governors</i> and GOVERNOR for details.	
Gyro, gyroscope: equipment that senses change in direction and provides input to compensate for that change. For description of aircraft use, see p. 64. For description of types, and helicopter use, see GYRO SENS .	
GYRO SENS (HELI) : gyro sensitivity programming designed to ease the setup and use of gyroscopes on model helicopters. Manual pages include extensive descriptions of gyro types.	89
Gyros and Governors	89
Heading-hold gyro: gyro that specifically measures the unwanted deflection angle and compensates until a corresponding angle has been returned. See <i>Gyros and Governors</i> .	
HELI : model type, rotary wing. See MODEL TYPE .	
Helicopter radio: transmitter that includes helicopter-friendly switch and control layout and sufficient programming to at least support a 5-channel helicopter. The 9CA and 9CH radios both contain all needed programming. The 9CH has a more heli-friendly layout (through switch positioning and no ratchet on throttle for easier hovering)	
High band: 72MHz equipment on a channel from 36 to 60. <i>Receiver</i> channel may be changed to any channel within the high band without needing retuning. <i>Transmitter</i> must not be changed except by certified technician.	8
High Rate: See D/R,EXP .	
Hover: to maintain a stationary position relative to a point on the ground.	
HOVERING PITCH : see <i>Hovering setups</i> .	
HOVERING THROTTLE : see <i>Hovering setups</i> .	
Hovering setups: in-flight adjustments to pitch and throttle curves around center THROTTLE STICK position (the ideal hovering point).	88
Idle management: varying settings and control of the model's idle. Ex: using IDLE-DOWN to lower engine's idle point for landings and certain maneuvers; using THR-CUT function to safely and accurately shut the engine off as needed without requiring constant adjustment of throttle trims.	33
IDLE-DOWN : offset mix that slows the engine's idle point (decreasing the amount of travel of the throttle servo when at low THROTTLE STICK POSITION). Typically used to keep the model sitting still on the runway prior to take off, for slow aerobatic maneuvers such as spins, and for landings. See <i>Idle management</i>	33
IDLE-UP : separate condition created to allow inverted and other types of flight with a helicopter not easily achieved in the normal condition. Note: the idle-ups are activated by activating their throttle curves. Also note that OFFSET is available to create separate trims within each condition.	85
In-flight needle control: see THROTTLE-NEEDLE .	
INH : makes a feature inactive/unable to be used. When a function is inhibited, it cannot be used even if the assigned switch is ON. Turns off functionality without losing any settings. Only visible in specific features.	
Inhibit: see INH .	
Installation: radio installation and setup.	16
Inverted: to fly a model upside-down.	
Inverted flight control programming: not available in the 9C. Most modelers no longer use this "crutch" to fly inverted, instead learning to recognize the model's behaviors when inverted and compensate appropriately.	
Kill switch: (1) throttle cut switch to close carburetor (see THR-CUT , p. 33). (2) gasoline ignition engine kill switch which removes spark to the plugs to stop the engine.	64
Launch setting: (GLID) see START-OFS .	

Linear Mix: a mix that maintains the same relationship of master to slave throughout the whole range. Ex: a mix from one flap servo to another flap servo at 100% causes the 2nd servo to follow the first servo's movement exactly through all points of travel. See *Programmable mix*.

LINK: mixing function that allows multiple mixes to work in conjunction. See *Programmable mix*.

Lithium battery: see *Backup battery*.

Linear: linear, directly proportional. See **AIRBRAKE**.

Low Band: 72MHz equipment on a channel from 11 to 35. *Receiver* channel may be changed to any channel within the low band without needing retuning.8

LOW BATTERY warning: transmitter's battery is below a safe flight voltage. Recharge immediately. See *Error messages*.

Low rate: see **D/R, EXP**.

MANUAL: controlled by a switch. Ex: see **AIRBRAKE**.

Master: the primary control. See *Programmable mix*.

Mechanical gyro: uses a mechanical gyroscope (like a child's toy gyro) to sense change of angle. See *Gyros and Governors*.

MEMORY MODULE INITIALIZE: warning to indicate that the **CAMPac** installed in the port is not yet formatted or formatted for a different model of transmitter. Pressing the **MODE BUTTON** initializes the **CAMPac**, deleting any existing data and formatting the **CAMPac** for use in the 9C. See *Error codes*.

MHz: Megahertz. Unit used to express frequency. 72MHz channels are aircraft only frequencies; 75MHz are ground model only frequencies; 27MHz are air and ground both. 50MHz is legal for HAM amateur license holders. See *Frequency*.

Mix, mixing rate, mix offset, mix links: See *Programmable mix*.

MIXER ALERT warning: notifies user that a mix is activated which is not considered desirable for engine startup. See *Error messages*.

Mode: definition of which channels are assigned to which **STICK** movements. All 9C radios shipped in the US are Mode 2, with elevator and aileron on the right **STICK**. To change mode, please visit www.futaba-rc.com.

MODE/PAGE BUTTON: control button on radio's face used in various parts of programming.11

MODEL COPY: used to duplicate the settings of one model already in memory into a second model memory. Often used to set up 2 similar models, or make a copy of a working model to experiment with new setups. Also used to copy models to/from the **CAMPac** data storage unit.26

MODEL NAME: gives each model memory an 8-character name for easy recognition. In **MODEL** submenu.27

MODEL RESET: restore all data in a single model memory to defaults, including name and model type. See **RESET**.

MODEL SELECT: choose the model memory you wish to modify or fly. In **MODEL** submenu.25

MODEL SELECTION ERROR: the memory last loaded in the transmitter is not currently available (usually because it is on a **CAMPac** not currently in the transmitter). See *Error messages*.

MODEL TYPE: select the type of model the aircraft is, including airplane, 2 glider types, and 5 heli types.28

MODUL: modulation, means of transmitting data (PPM, PCM). In **PARAMETER** submenu.31

Module: electronic component which can easily be removed/replaced into the transmitter, which houses all transmission components. Transmission frequency can be safely, legally and easily changed (including from band to band) by changing the module. TP-FM is the standard module, available on any 50MHz or 72MHz frequency. You may also purchase TJ75FM for ground use, 75MHz.9

Name: see **MODEL NAME**.

Neckstrap: optional strap to suspend transmitter during use. Futaba stock # FTA8. See *Accessories*.

Ni-Cd: Nickel Cadmium rechargeable battery. Typically used to power transmitter and receiver. See *Battery care and charging*.

NiMH: Nickel Metal Hydride rechargeable battery. Newer battery technology than Ni-Cd. Longer run times but more specific peak charging requirements. [Require a (zero) delta peak charger labeled specifically for use with NiMH batteries.]

NORMAL: trainer mode that does not give student radio the computer programming features of the master radio. See *Trainer*.

NT8S: standard transmitter battery pack. See *Accessories*.

NULL: not assigned or never changed. Ex: a mix which has a null switch assignment is always active, and can never be changed in flight (turned off) no matter which switch is moved.

OFFSET: (**HELI**) separate trim settings available to each idle-up (using **CONDITION**) setting, or assigned to separate switches from the condition switches. When offset is **ON**, movement of the trim levers adjusts the **OFFSET**, not the normal condition's trims.86

Offset mix: mix that independently moves the slave servo a set percentage of its total throw, not in relation to any master. See *Programmable mix*.

PA2: Pilot Assist. Optional onboard device that uses optical sensors to correct model's orientation to upright.

PARAMETER submenu: sets specific parameters. Includes reset, type, modulation, second aileron servo setup, and **ATL**. . . .28

PCM: Pulse Code Modulation. An electronically encoded method of transmitting data to a receiver to help minimize the effects of interference. (Transmission is on an FM wavelength, and uses FM crystals, module and trainer cord.). See *Modulation*.

Peak Charger: charger that automatically stops charging when the battery is fully charged (commonly called "peaked"). See *Battery care and charging*.

Piezo gyro: gyro that uses a piezo crystal to sense angular changes. See *Gyros and Governors*.

Pitch-to-rudder mix: see **REVO**.

PITCH CURVE: (**HELI**) curve that sets the response of the collective pitch servo(s) to movement of the throttle/collective **STICK**. Independently adjustable in the normal flight mode, one for each of the 3 idle-ups, and one for throttle hold. Adjusted to provide ideal blade response for various types of maneuvers being performed. For simplicity, the normal condition's curve may be set in the **BASIC** menu. All 5 curves are also adjustable in the **ADVANCE** menu.84

PPM: Pulse Position Modulation. Also known as FM. Type of signal transmission. See *Modulation*.

Programmable mix: used to cause specific servo responses to specific inputs separate from the basic control setups. Includes extensive definitions of types and examples.59

Range check or test: to test the transmitter's control over the model at a specific distance as a precaution in checking its proper operation prior to flight.16

Rate: amount of control given. Ex: see *Programmable mix*.

RESET: to delete all data in the existing model only. *User CANNOT erase all data in the radio. Only service center can do so.* Part of **PARAMETER** submenu.28

Retractable landing gear: landing gear that is brought up into the model during flight.64

REVERSE: servo reversing. Used to reverse the direction of a servo to ease installation and set up.31

Rudder-to-aileron mix: (**ACRO / GLID**) used to counteract undesirable roll (roll coupling) that happens with rudder input, especially in knife-edge. Gives proper aileron input to counteract roll coupling when rudder is applied. Not a preprogrammed mix. See *Programmable mix*. This is the default programming for one linear and one curve mix in **ACRO** and **GLID**.

Rudder-to-elevator mix: used to counteract undesirable pitch (pitch coupling) with rudder input, especially in knife edge flight. Not a preprogrammed mix. See *Programmable mix*. This is the default programming for one curve mix in **ACRO**.

Rudder-to-throttle mix: (**HELI**) adds throttle to counter the added load from increasing pitch of the tail blades, maintaining a constant head-speed with rudder. (This is a minor effect and is not critical in most helicopters.) Not a preprogrammed mix. See *Programmable mix*.

Rx: receiver.

SAFE MODE: feature in snap roll programming that does not allow a snap roll if landing gear is lowered. See *Snap roll*.

Sailplane: glider, non-powered model aircraft type. See **GLID / MODEL TYPE**.

SELECT (CURSOR) BUTTONS: controls used in various ways during programming. 11

Select a model: see **MODEL SELECT**.

Service Center. 3

SERVO: bar graph display on screen to show real time movement/commands sent to servos by transmitter in response to user movements. Also includes a servo test feature. 42

Servo reversing: see **REVERSE**.

Servo Slow: see *Channel delay*.

Servo testing, servo display: See **SERVO**.

SET: to accept. Usually done by pressing and holding the dial when instructed.

Slave: channel that moves in response to the command of the master. See *Programmable mix*.

Slaving servos: see programmable mix, p. 59.

Slider assignability: sliders on side of radio, known as *VR(D)* and *VR(E)* in programming, may be assigned to control channels 5-8 in **AUX-CH**, used as the primary control of a mix in programmable mixes, etc.

Slow: see *Channel delay*.

Smoke system: injects a specialized smoke oil into the hot exhaust to create air-show like smoke trails. 64

SNAP ROLL (ACRO) combines rudder, elevator and aileron movement to cause the aircraft to snap or spin at the flip of a switch. 9C offers 4 separate snaps with 1 or 2 switches used for selection. 51

Speed Flaps: main flaps on a 5-servo glider.

SPEED OFS (GLID): speed run offset programming. Offsets aileron/elevator/rudder settings to provide minimum drag for high speed flight. 71

START OFS (GLID): start offset programming. Offsets aileron/elevator/rudder settings to provide for maximum lift during launch. 71

Stick adjustments: change stick tension and height. 15

STk-THR: assigned to *THROTTLE STICK*. See **AIRBRAKE** for example.

SUB-TRIM: used to fine tune the center or neutral point of each servo. Allows full trim function from the trim sliders for flight trimming. 41

SWASH AFR (HELI, CCPM types only) adjustment of the travel of all servos involved in the particular control's movement *only* during the movement of that control. Ex: reverse the direction of movement of collective pitch while not affecting the direction of movement of either cyclic control. 79

Swashplate type: (**HELI**). Part of the model type selection process. Selects specific heli swashplate geometry, such as one of four available types of "CCPM." 77

Switch programmability: MOST features are reassignable to a variety of switches, including simply moving an auxiliary control such as flaps from the stock dial to a switch or other location. See **AUX-CH**.

Synthesized module/receiver: The 9C is compatible with the R309DPS Futaba synthesized receiver that can be used on any 72MHz channel. There is not a synthesized transmitter module that is safe/FCC certified/approved for use with the 9C at the time of this printing. 10

Technical Specifications.	9
Thermal hunting setup: using specific programming setups to have the model respond noticeably to the lift of a thermal. Not a preprogrammed mix. See <i>Programmable mix</i> .	
THR-DELAY: (ACRO) throttle delay, slows engine servo response to imitate the spool-up action of a turbine engine. May also be used creatively to create a delayed servo on a different function (see www.futaba-rc.com/faq/faq-9c.html .)	57
THR-REV: reverses the throttle trim function to the top of the <i>THROTTLE STICK</i>	31
THROTTLE-NEEDLE: (ACRO / HELI) curve mix that adjusts a second servo, controlling the engine's mixture, to get optimum RPM and performance from the engine at all settings.	56
Throttle-to-rudder mix: used to compensate with rudder when throttle is applied on take off. Not a preprogrammed mix. See <i>Programmable mix</i> . This is the default setting of a mix in ACRO and GLID .	
THROTTLE CURVE: (HELI) adjusts how the servo responds to the <i>THROTTLE STICK</i> position along a 5 point curve. Separate curves available for each idle-up and normal. For simplicity, normal curve may be edited from BASIC menu. All curves may be edited together in the ADVANCE menu. Activating an idle-up's throttle curve is what activates that idle-up. .81,84	
Throttle cut or throttle kill: THR-CUT. (ACRO / HELI) Offset mix which closes the throttle servo to a set position when the assigned switch is moved to shut the engine off without having to fiddle with trim settings.	33
THROTTLE HOLD: (HELI) makes the throttle servo non-responsive to <i>THROTTLE STICK</i> position, and moves the throttle to idle. Used to practice autorotations. NOTE: THR-HOLD must be activated, then the default pitch curve adjusted properly.	83
Throttle trim adjustment: see ATL to change throttle trim from "idle only" to full trim control like all other channels. See THR-REV to reverse <i>THROTTLE STICK</i> completely, including moving trim to the top of the <i>THROTTLE STICK</i> . See also <i>Idle management</i> for details on idle down and throttle cut functions.	
TIMER: adjust the timer functions, used to keep track of flight time on a tank of fuel, etc. The "trigger" to turn timers on/off may be programmed.	38
TP-FM: single-frequency module. See <i>Module</i> .	
TRAINER: software that allows 2 radios to be connected via trainer cord, giving student control of all or some of the channels of the aircraft at the flip of a switch. FUNC trainer mode allows student to use mixing in the master transmitter, for example dual rates, exponential, fly a 5-channel helicopter with a 4-channel buddy box, etc.	40
Trainer box: stripped-down radio system which does not have the ability to transmit, is used only as a student's radio when instructing while using a trainer cord and the trainer programming.	
Trainer cord: cord used to connect two compatible radios to use for flight instruction. See <i>Accessories</i> .	
TRIM menu: adjusts rate at which the trim responds to movement of the trim sliders. Also has a reset function to reset the model's electronic trims to zero.	41
TRIM OFFSET: (HELI) sets an offset or adjustment of trim when switching between conditions. See <i>OFFSET</i> .	
TRIM option in mixes: ability to adjust the slave servo's center when the master servo's center is adjusted using the trim sliders (for example when using two separate flap servos). See <i>Programmable mix</i>	53
Triple rate: 3rd control travel setting available in flight. See D/R,EXP .	
Twin aileron servos: use of 2 or more servos on separate channels to control aileron action. Includes flaperon, aileron differential, and elevon.	44
Twin elevator servos: use of 2 or more servos on separate channels to control the elevator of a model. Includes elevon, ailevator, V-tail.	49
Tx: transmitter.	
Voltmeter, voltage reading: displays transmitter voltage on home screen.	18
VR(A-E): variable rate controls. Knobs and sliders on the radio. See switch assignment chart for default assignments.	

VR(A-C) are knobs; *VR(D-E)* are sliders on the case sides.

V-tail model Mix: (**ACRO / GLID**) programming used to control a V-tail model's tail surfaces, with 2 servos operating 2 control surfaces as both rudder and elevator. See *Twin elevator servos*.

Warning messages: cautions provided by the radio when certain potential problems exist. See *Error messages*.

Warranty information.3

Website: www.futaba-rc.com. Internet location of extensive technical information Futaba products.3

Whip antenna: aftermarket, shortened antenna. Not approved by Futaba.